

НАУЧИМ ИЗОБРЕТАТЬ
БУДУЩЕЕ

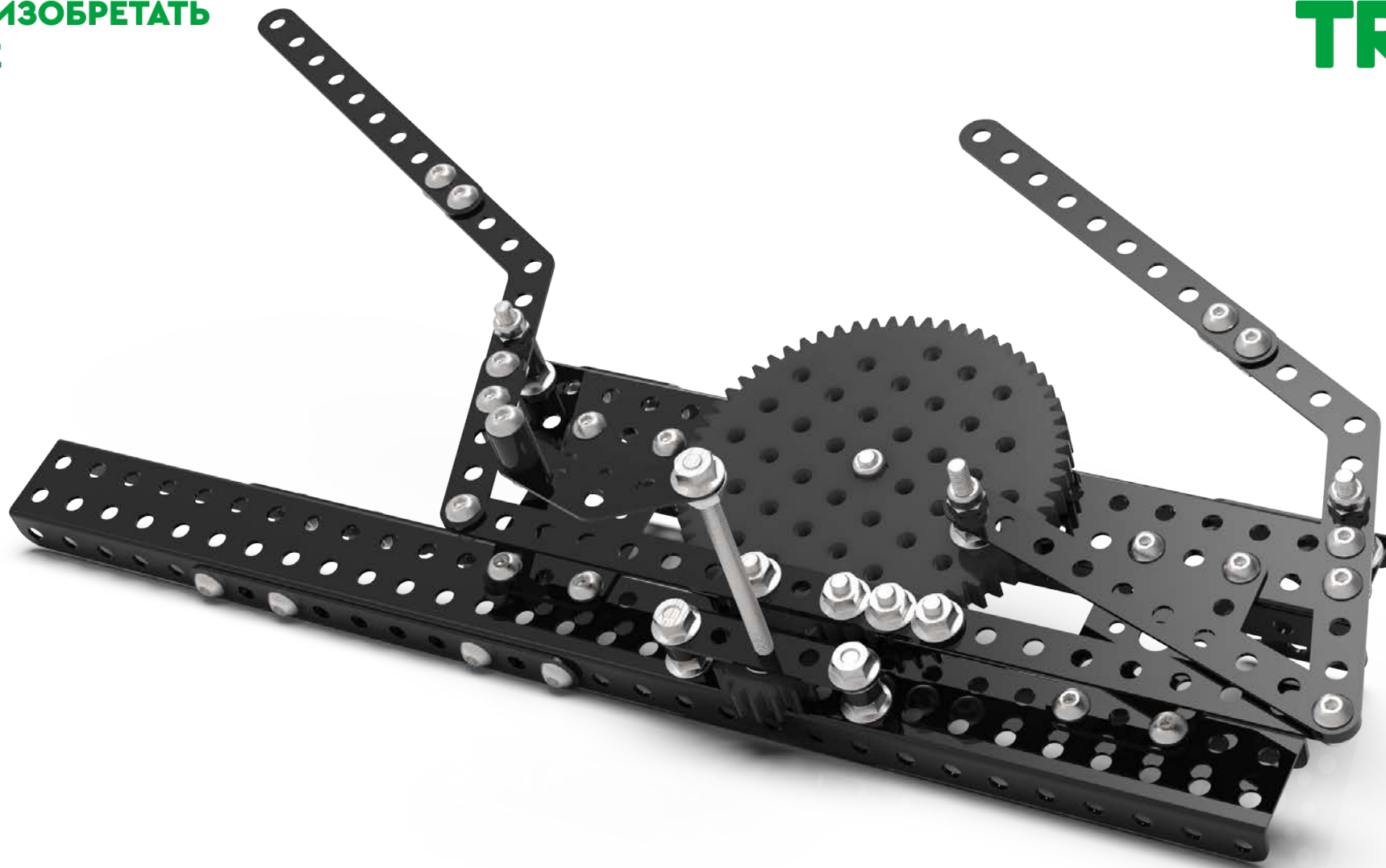









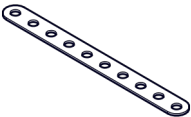

TRIK

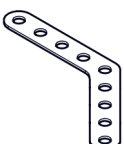
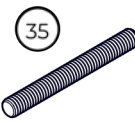
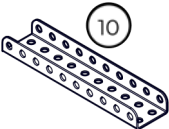
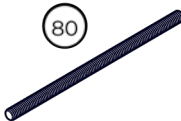
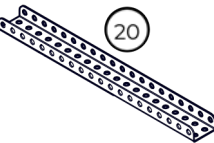

Дворники автомобиля

Инструкция по сборке

Перечень деталей

Название детали	Изображение	Количество (шт.)	Название детали	Изображение	Количество (шт.)
Пластина 1x5		4	Винт M4x16	 M4x16	3
Пластина 1x10		7	Винт M4x25	 M4x25	3
Адаптер силового мотора 25D плоский 3x5		4	Гайка M4 фланцевая		44
Угол плоский 135° 3x3		1	Гайка M4 стопорная		8
Угол плоский 135° 5x5		2	Шпилька M4x35	 35	1
Балка (1_2_1)x10	 10	1	Шпилька M4x80	 80	1
Балка (1_2_1)x20	 20	2	Шайба нейлоновая		2
Винт M4x8	 M4x8	34	Кольцо 3.4 мм		4

Название детали	Изображение	Количество (шт.)
Кольцо 5 мм		6
Шестерня малая		1
Шестерня большая		1

1

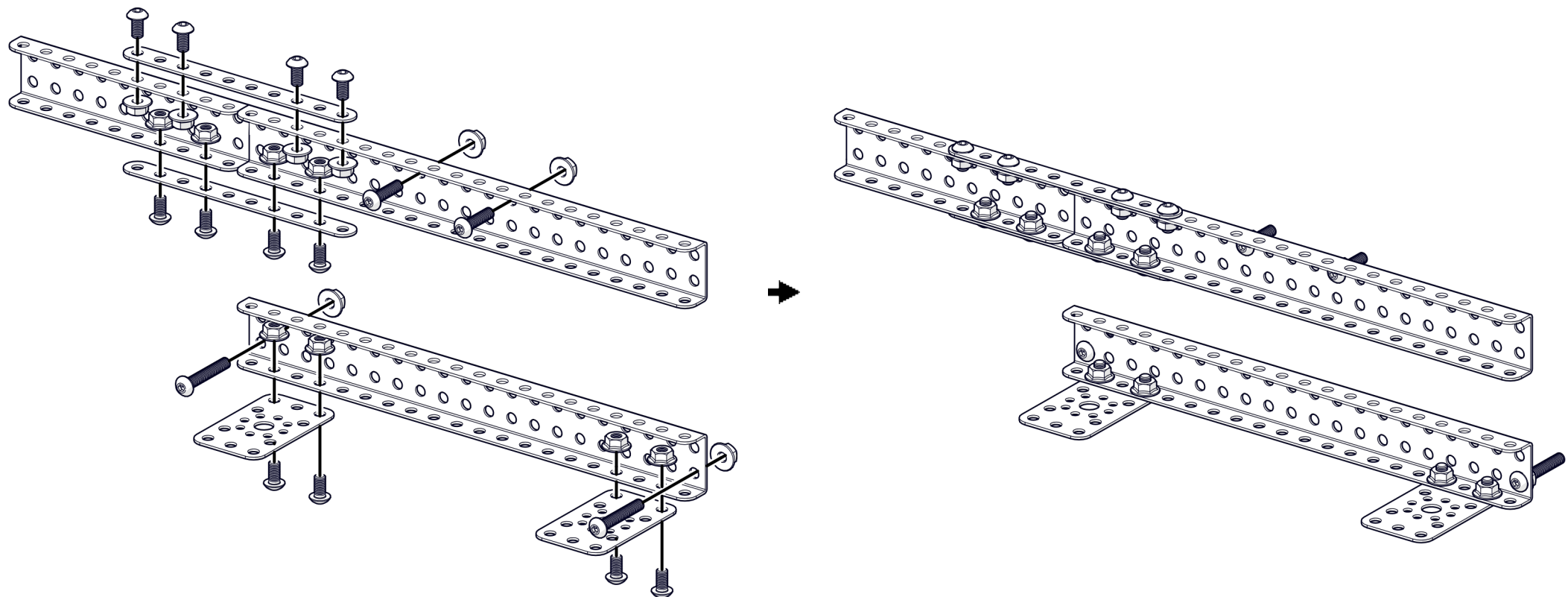
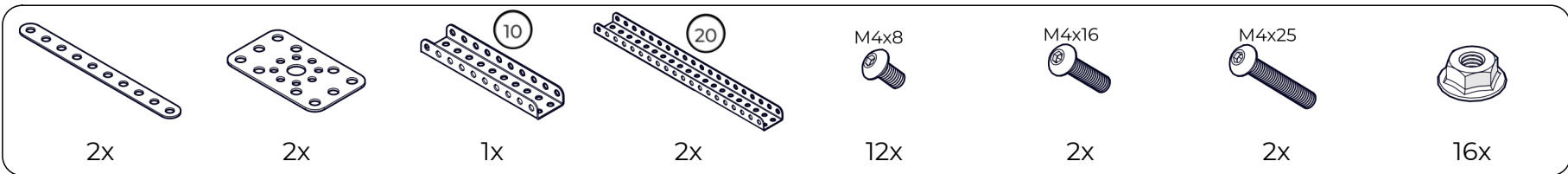

2

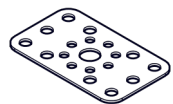

2x

M4x8



8x



8x

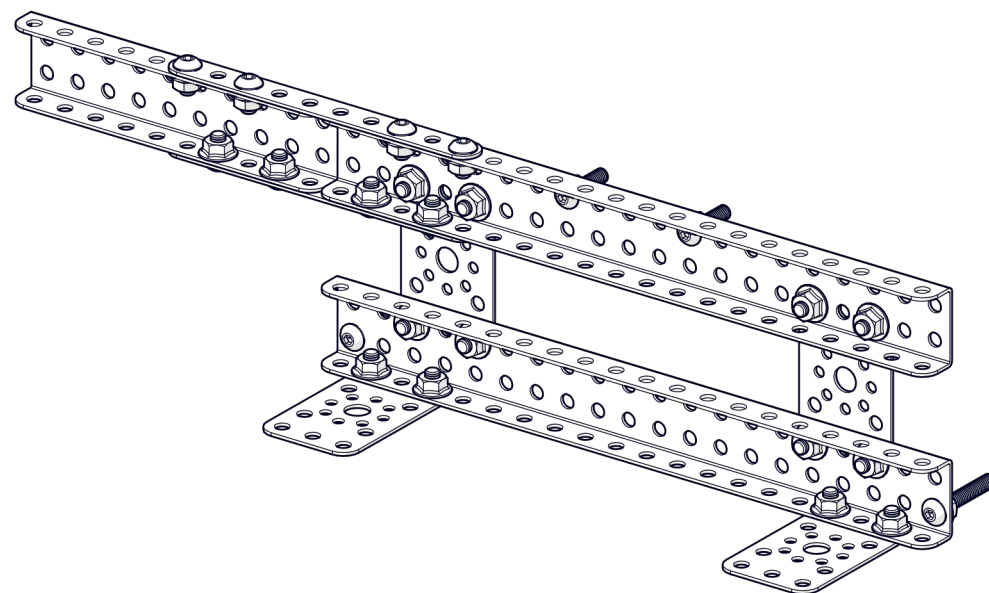
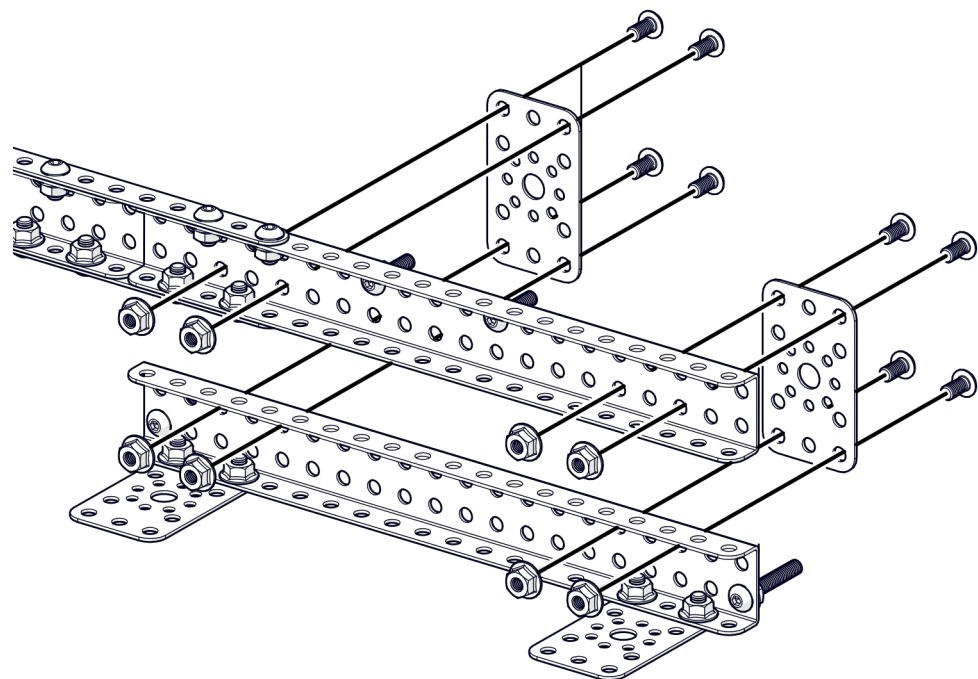

3

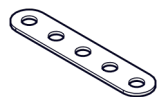

1x



2x



2x



1x

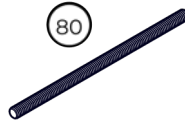

1x



4x

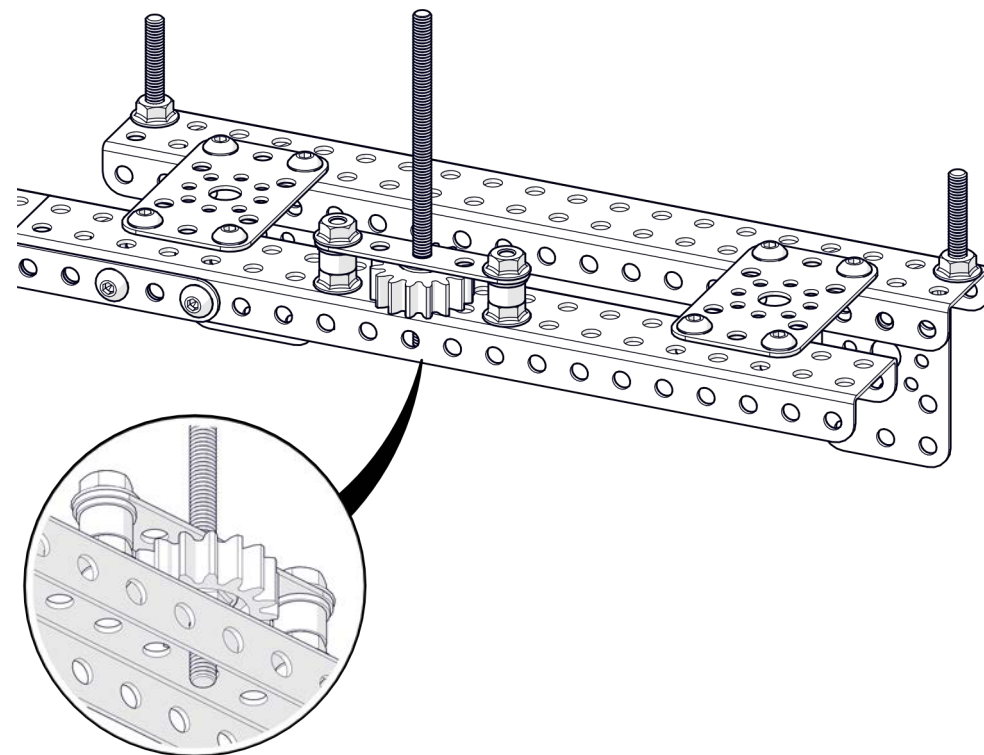
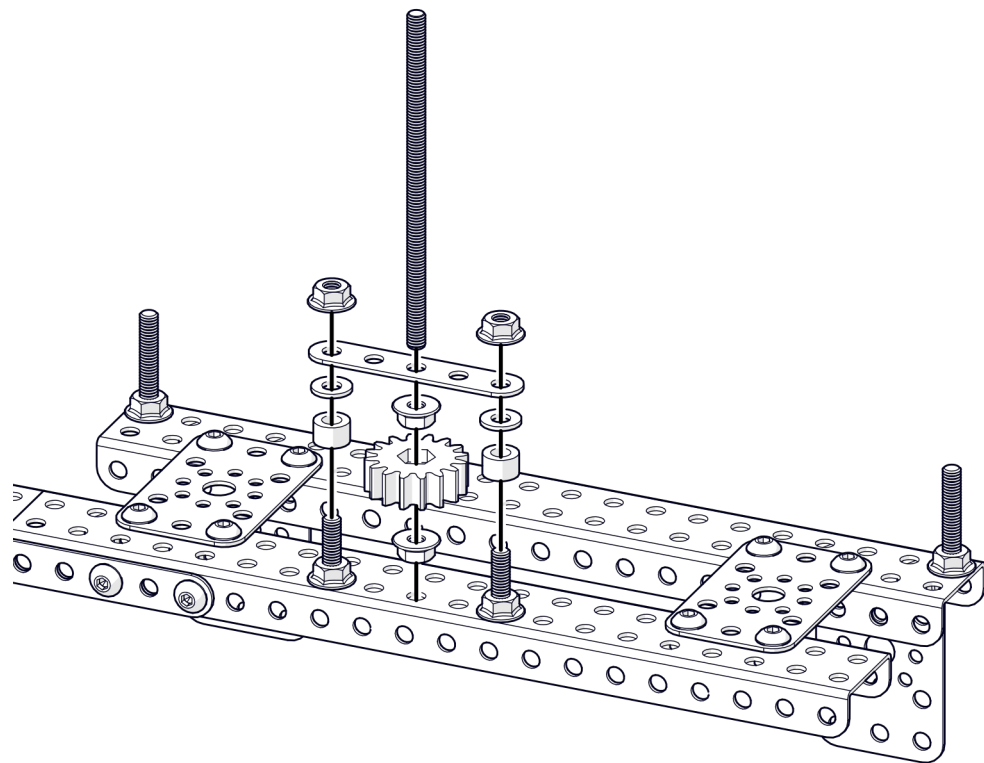

4

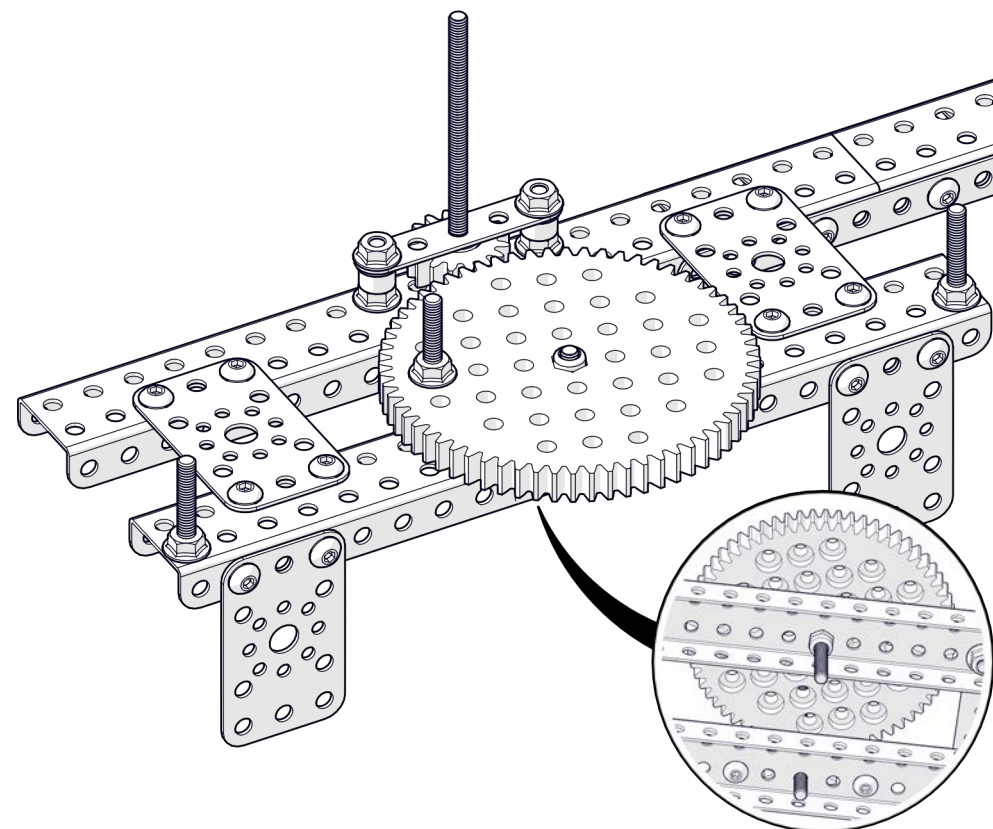
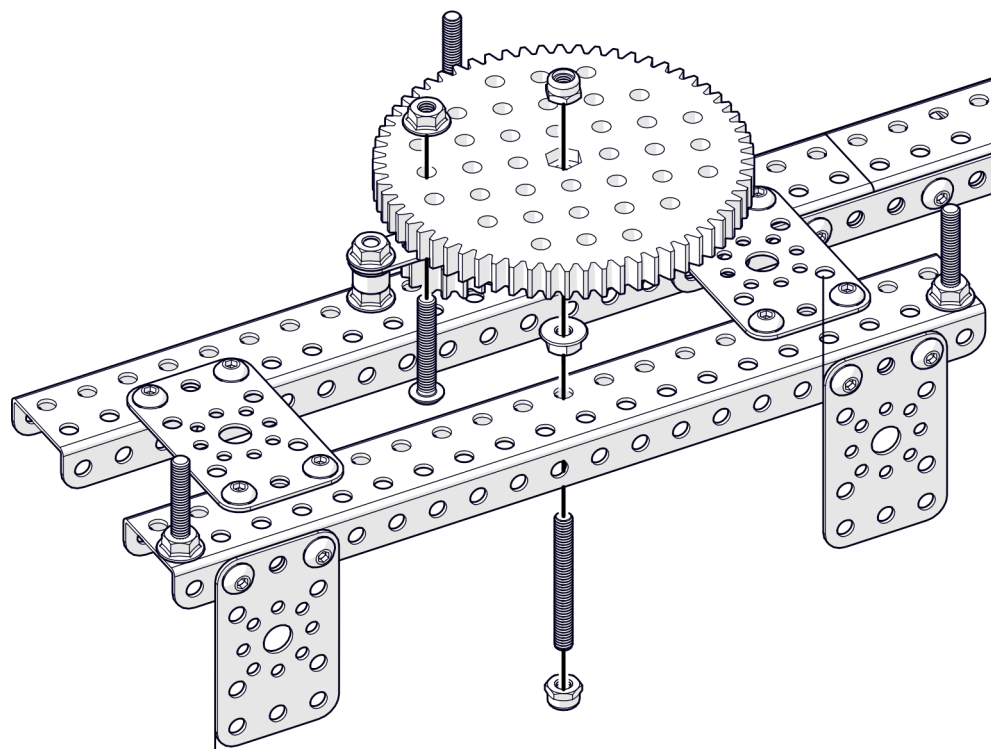
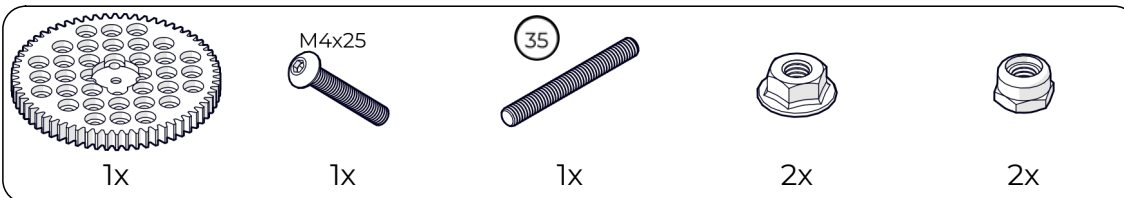

5

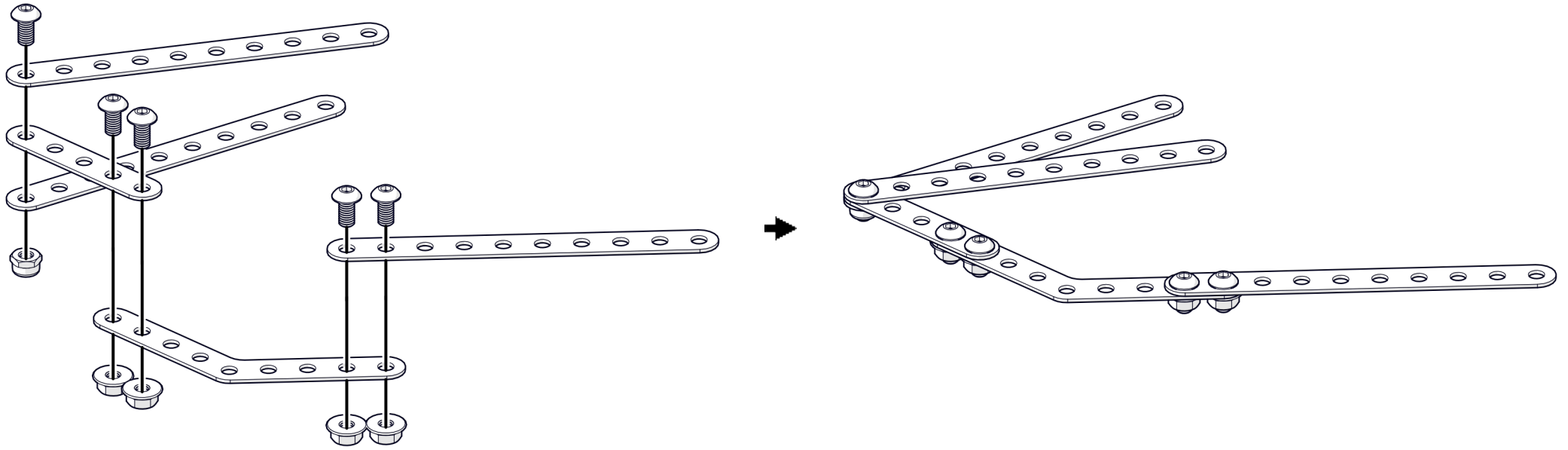
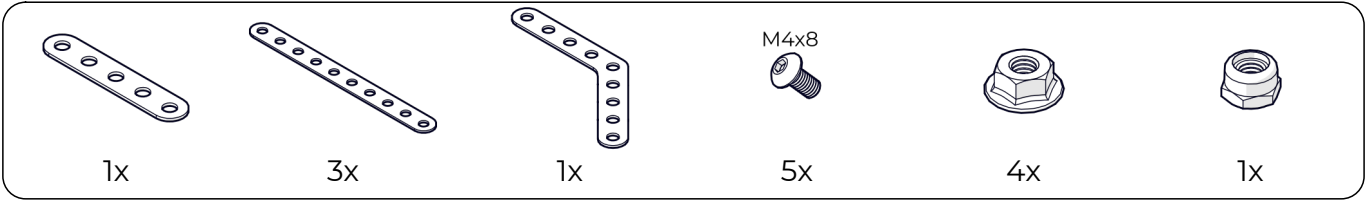

6

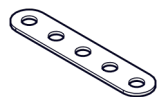

2x

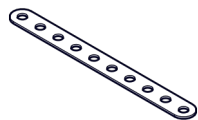

2x

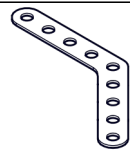

1x

M4x8



9x



8x



1x

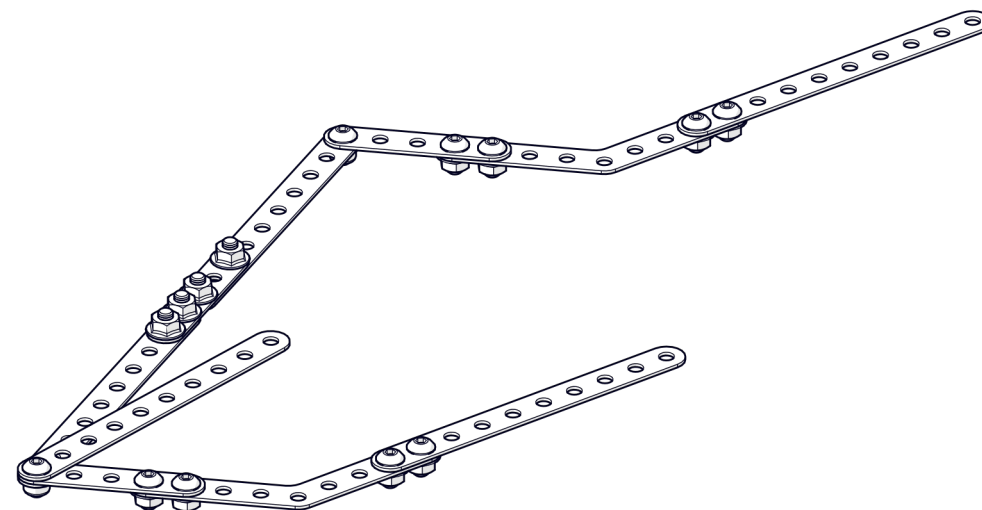
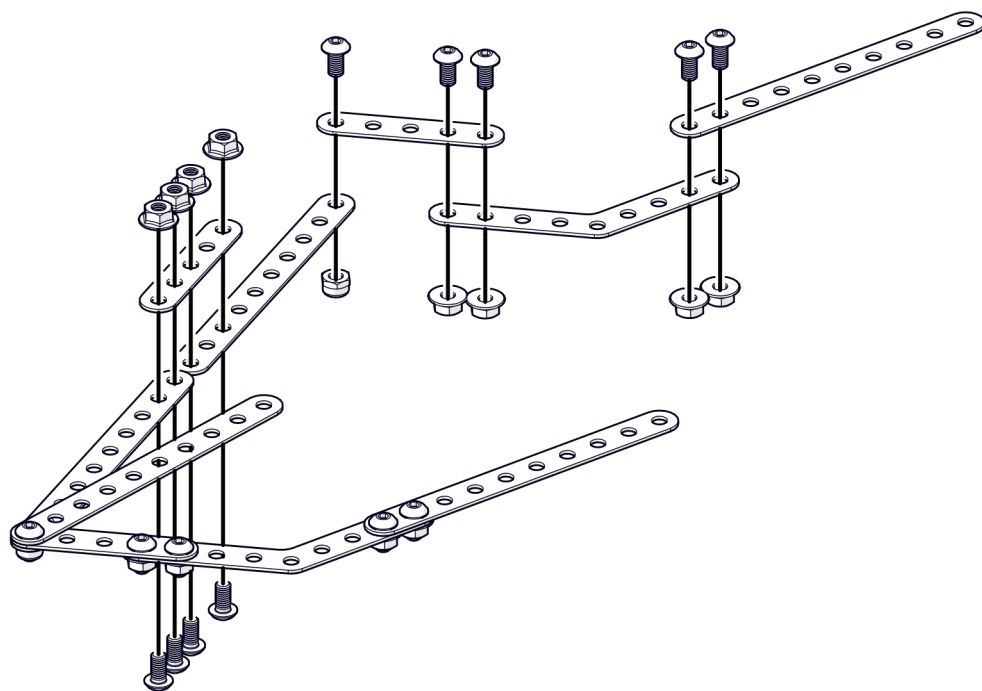

7



1x



4x



3x

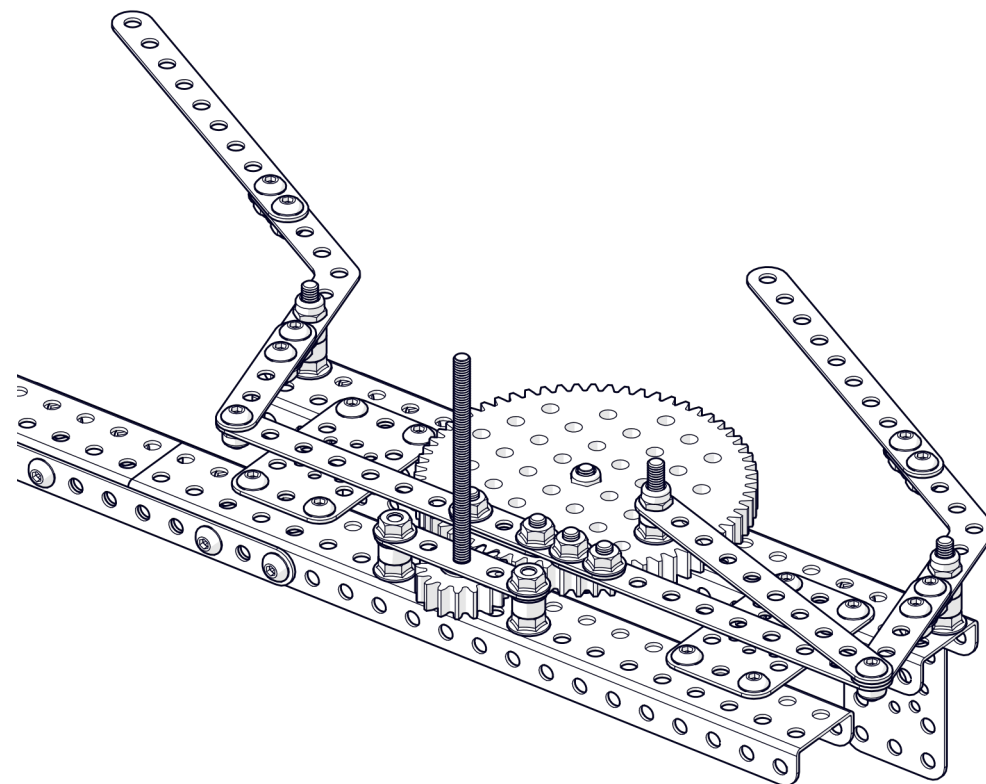
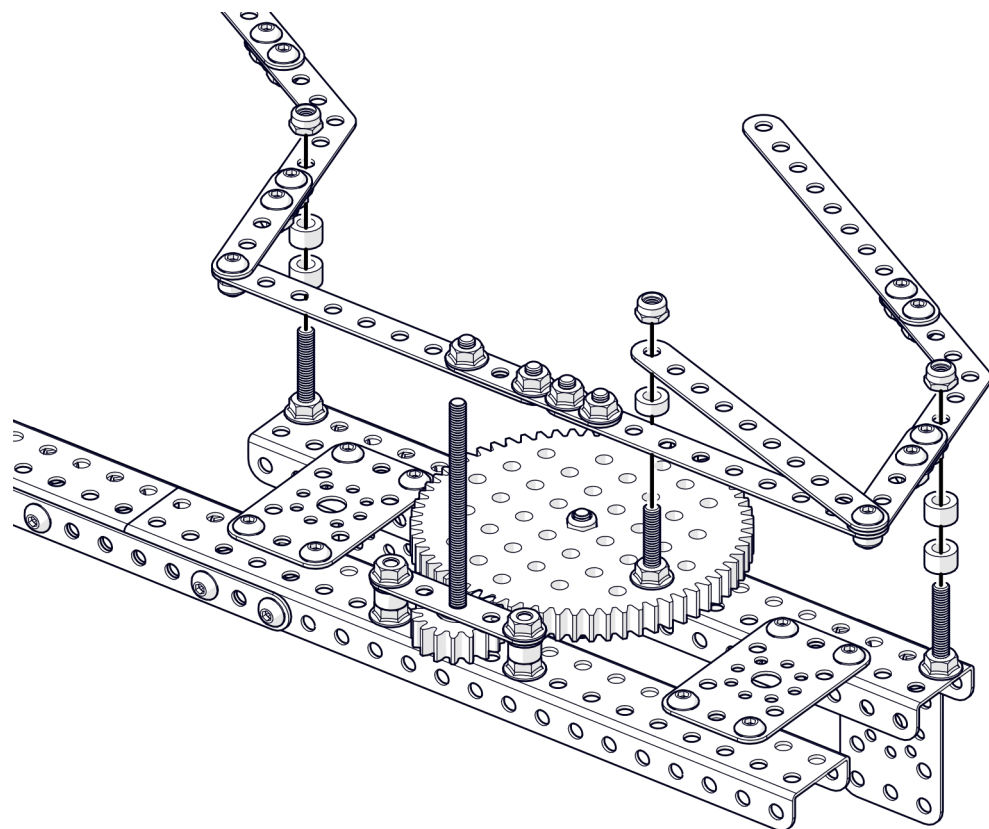

8

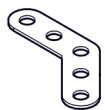

1x



3x

M4x16



1x



2x



1x

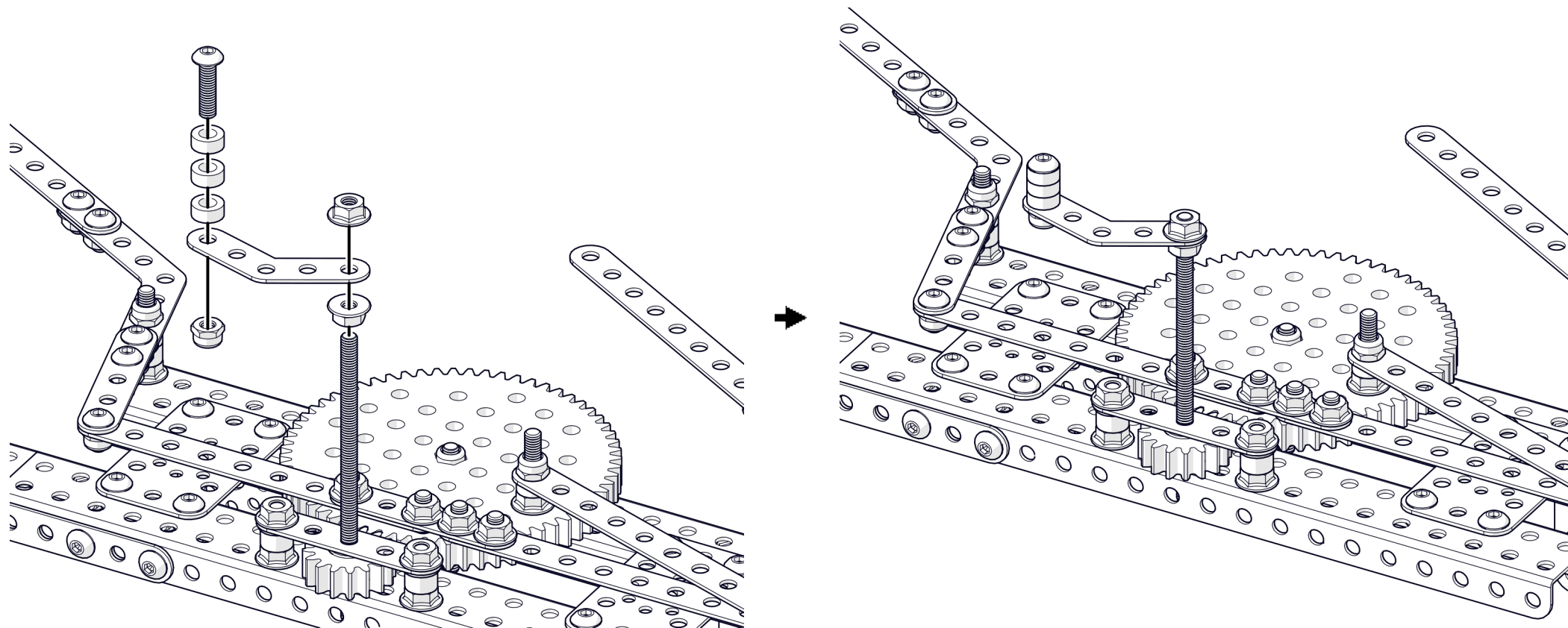

НАУЧИМ ИЗОБРЕТАТЬ
БУДУЩЕЕ

TRIK

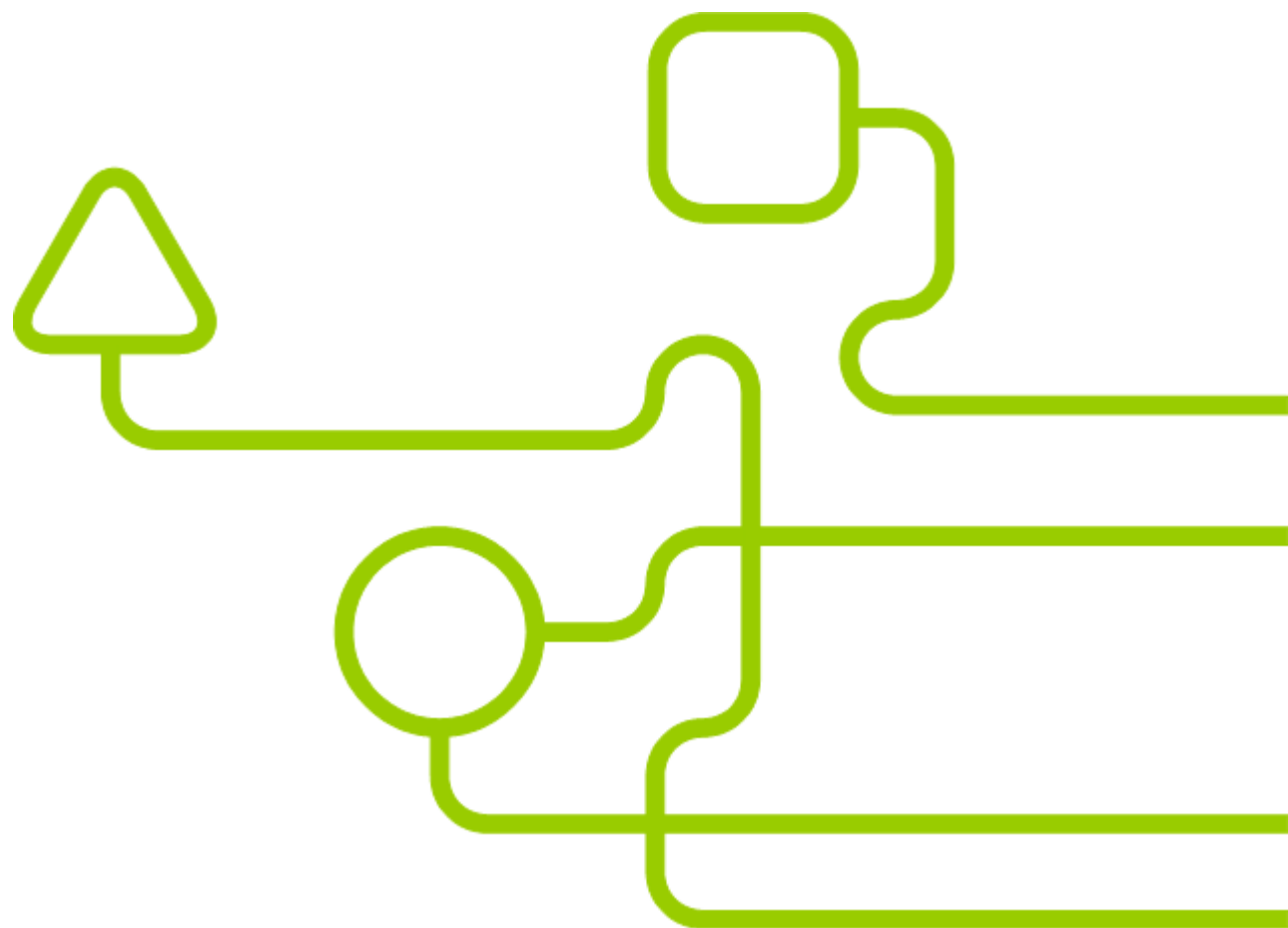

[trikset](#)

[trikset.com](#)

support@trikset.com

