

НАУЧИМ ИЗОБРЕТАТЬ
БУДУЩЕЕ

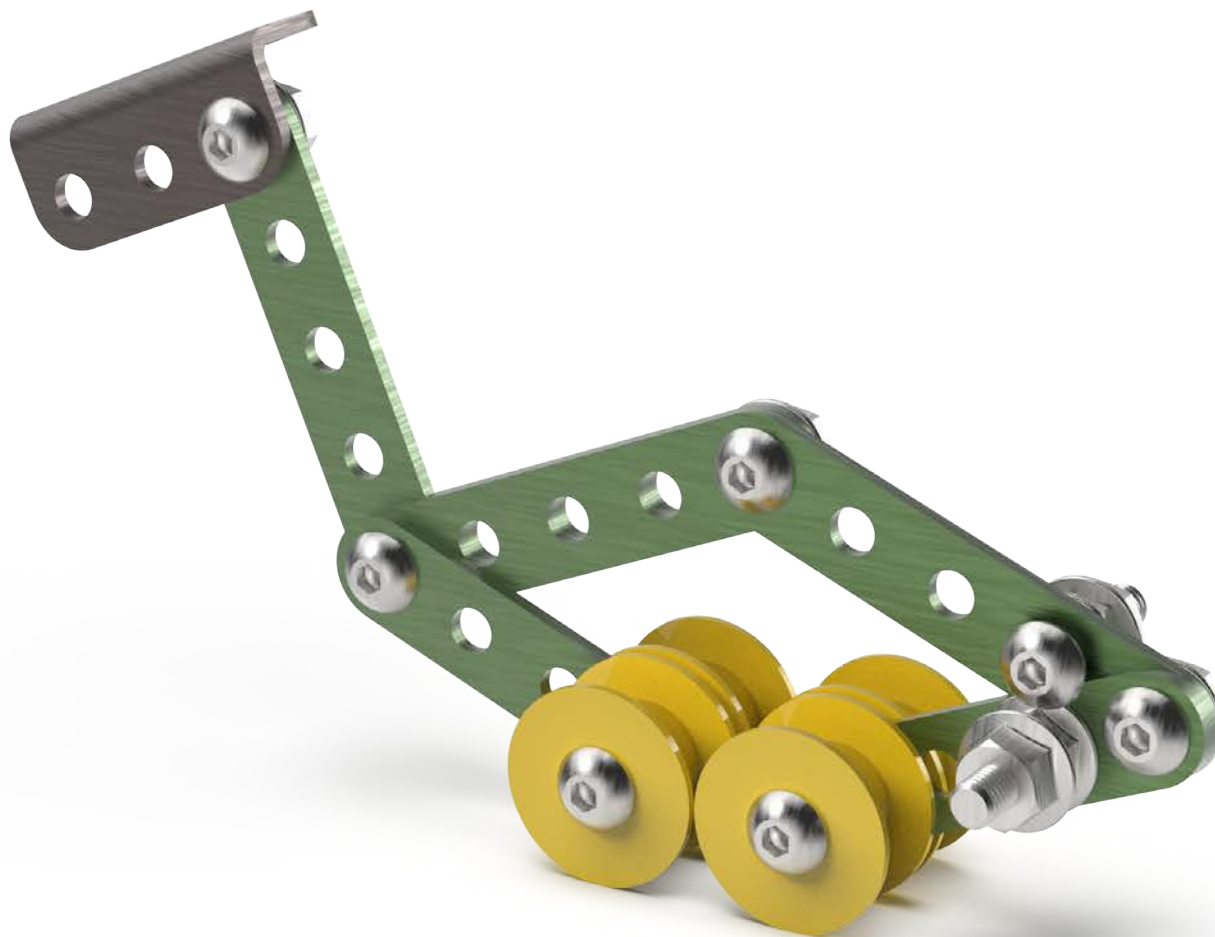





TRIK

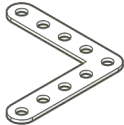
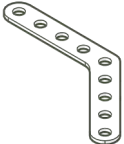
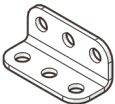

Динозавр







Инструкция по сборке

Перечень деталей

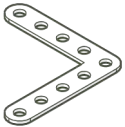
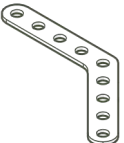
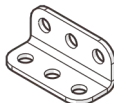
Название детали	Изображение	Количество (шт.)
Угол плоский 90° 5x5		1
Угол плоский 135° 5x5		2
Угол (1_1)x3		1
Винт М4x8	M4x8 	4
Винт М4x16	M4x16 	2
Винт М4x25	M4x25 	2
Гайка М4 фланцевая		8
Гайка М4 стопорная		2

Название детали	Изображение	Количество (шт.)
Шкив		4

1

				
1x	2x	1x	4x	2x
				
2x	8x	2x	4x	

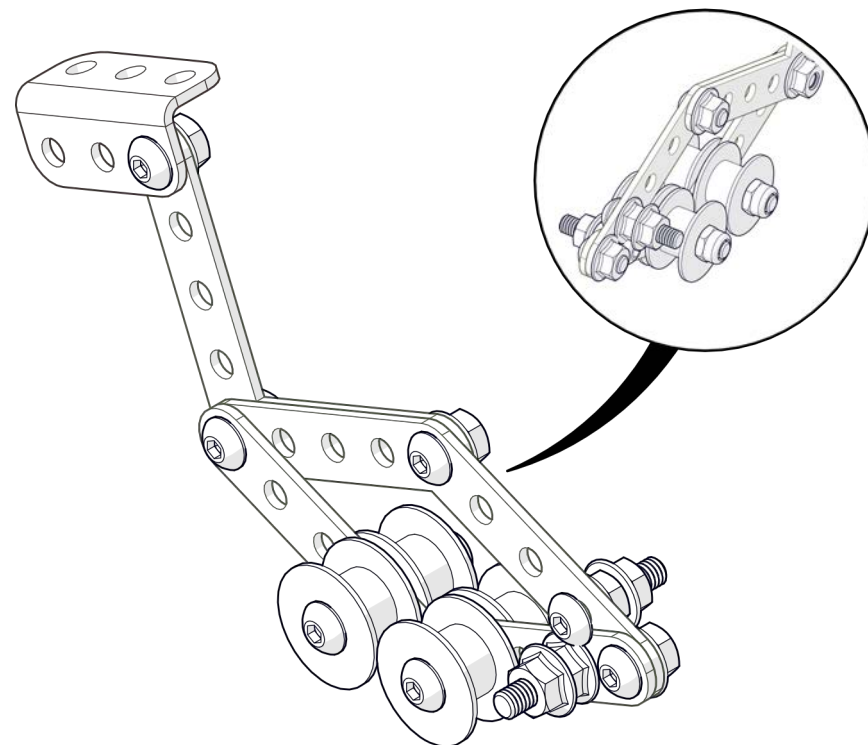
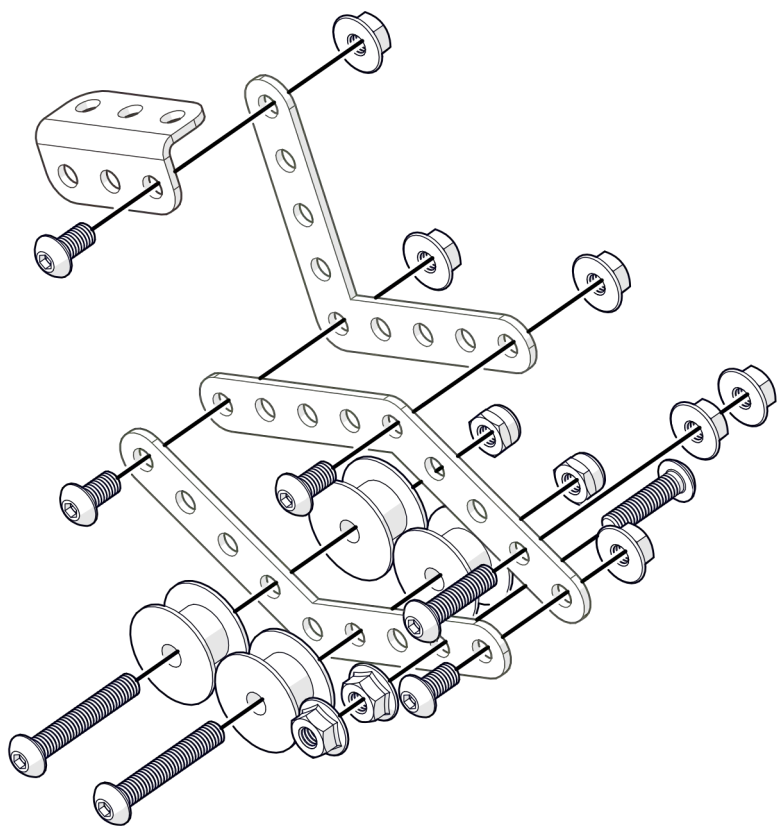

НАУЧИМ ИЗОБРЕТАТЬ
БУДУЩЕЕ

TRIK



[trikset](#)

trikset.com

support@trikset.com

