

НАУЧИМ ИЗОБРЕТАТЬ
БУДУЩЕЕ

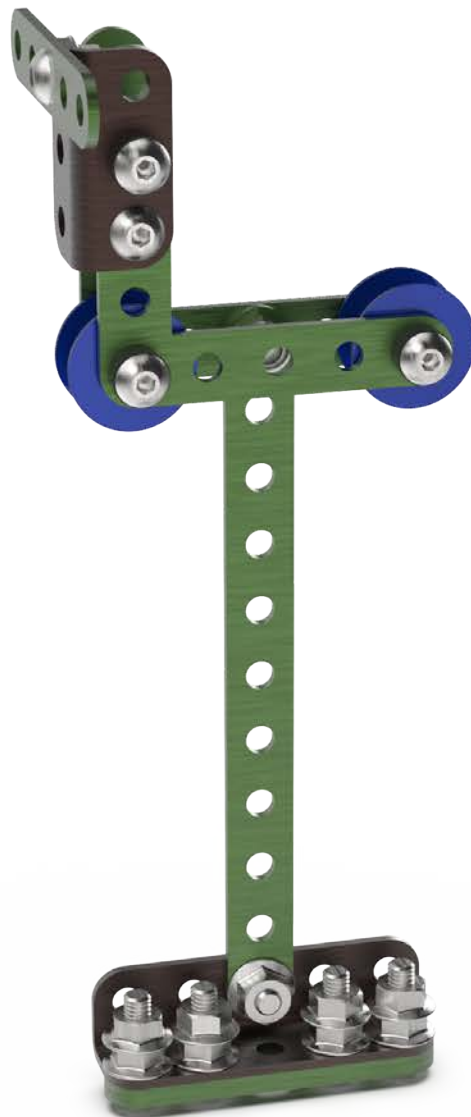









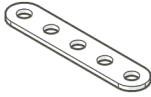

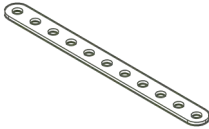
TRIK

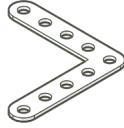

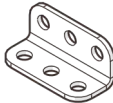
Самокат с противовесом

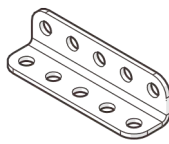
Инструкция по сборке

Перечень деталей

Название детали	Изображение	Количество (шт.)	Название детали	Изображение	Количество (шт.)
Пластина 1x5		3	Гайка М4 фланцевая		12
Пластина 1x11		1	Гайка М4 стопорная		3
Угол плоский 90° 5x5		2	Кольцо 3.4 мм		3
Угол (1_1)x3		1	Кольцо 5 мм		2
Угол (1_1)x5		1	Шкив		2
Винт М4x8	 M4x8	4			
Винт М4x16	 M4x16	4			
Винт М4x25	 M4x25	3			

1

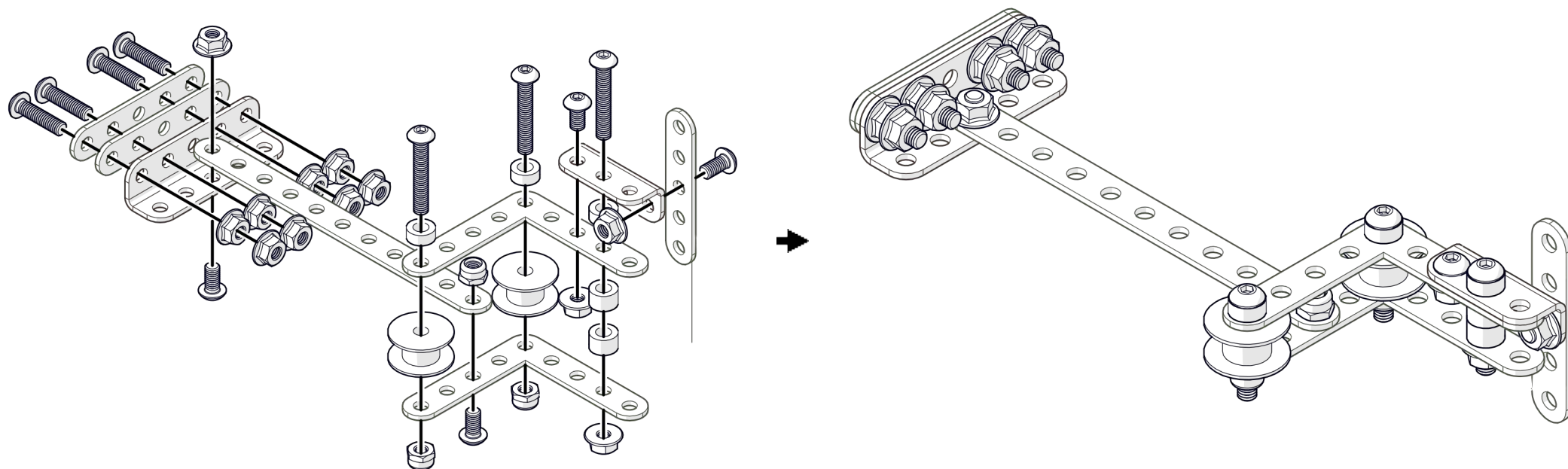
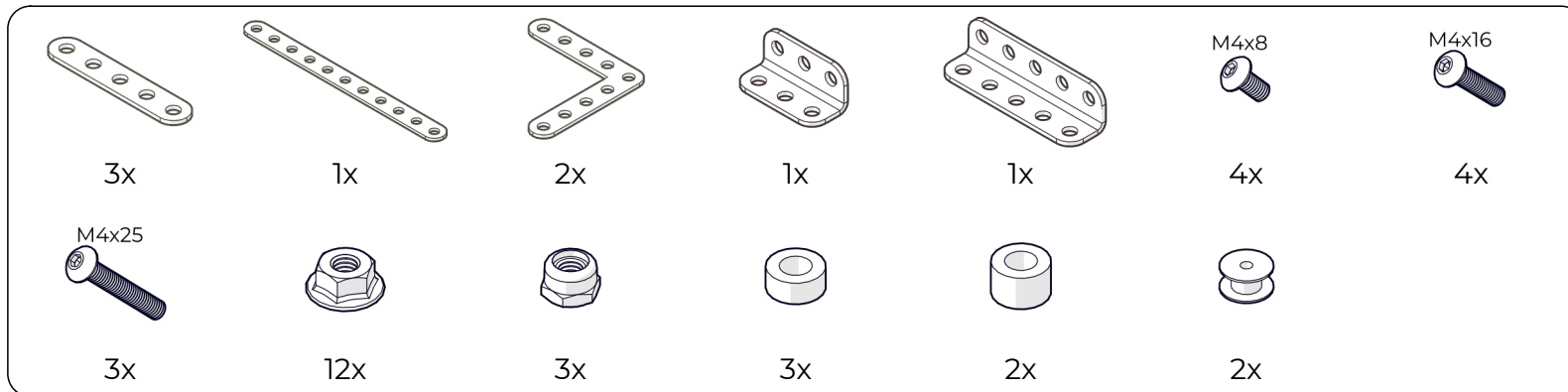

НАУЧИМ ИЗОБРЕТАТЬ
БУДУЩЕЕ

TRIK



[trikset](#)

trikset.com

support@trikset.com

