

НАУЧИМ ИЗОБРЕТАТЬ
БУДУЩЕЕ

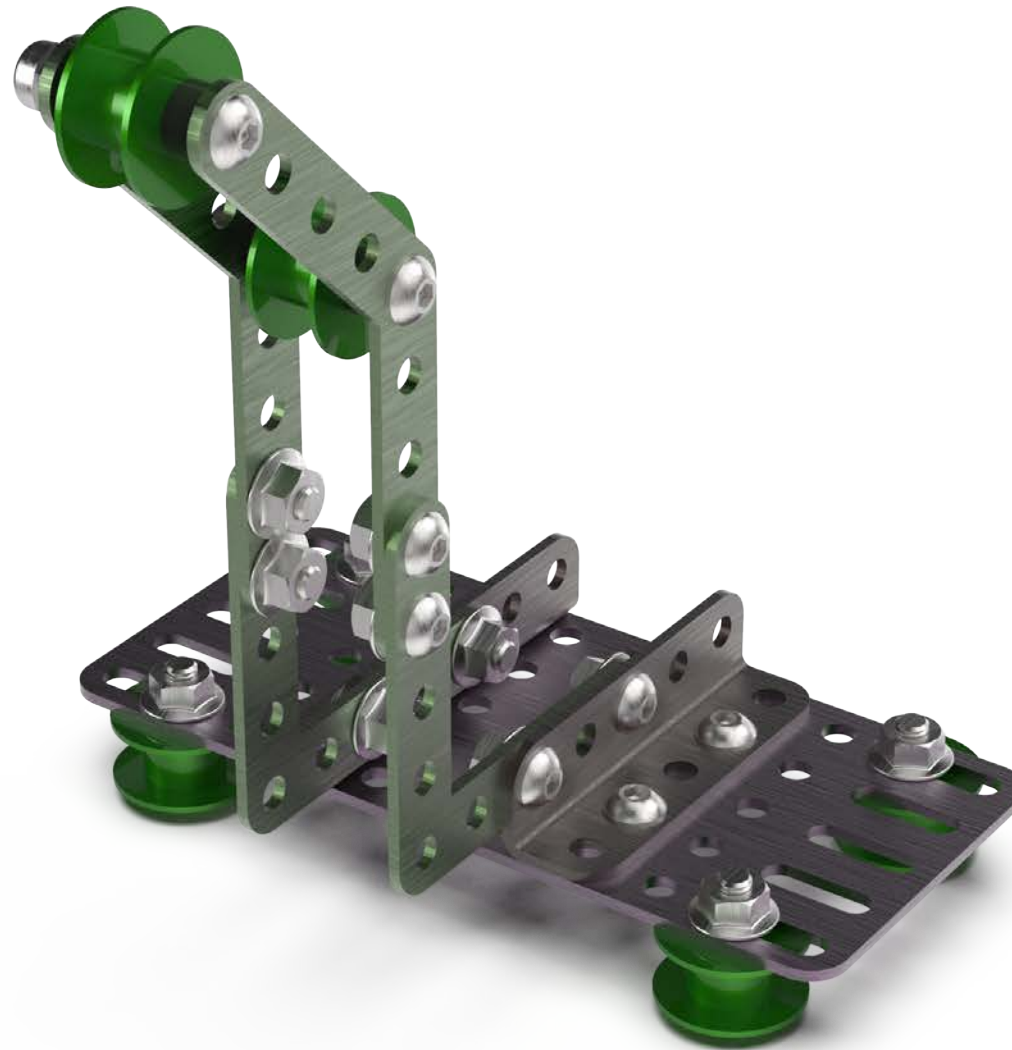







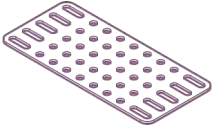

TRIK

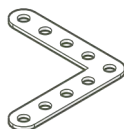

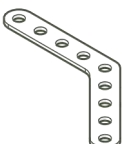
Таль

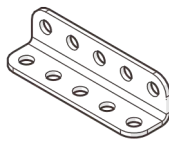
Инструкция по сборке

Перечень деталей

Название детали	Изображение	Количество (шт.)	Название детали	Изображение	Количество (шт.)
Пластина 5x11		1	Гайка М4 стопорная		2
Угол плоский 90° 5x5		2	Кольцо 3.4 мм		4
Угол плоский 135° 5x5		2	Шкив		6
Угол (1_1)x5		2			
Винт М4x8		12			
Винт М4x16		4			
Винт М4x25		2			
Гайка М4 фланцевая		16			

1

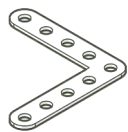

2x



8x

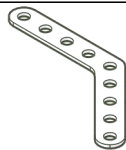

2x



2x

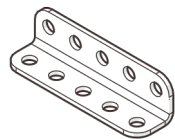

2x



8x



4x







2x

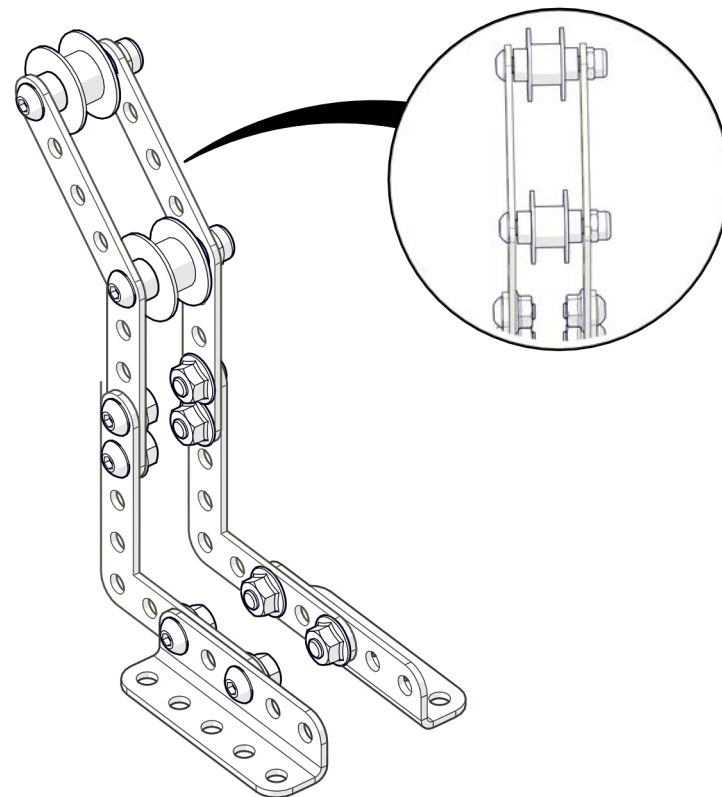
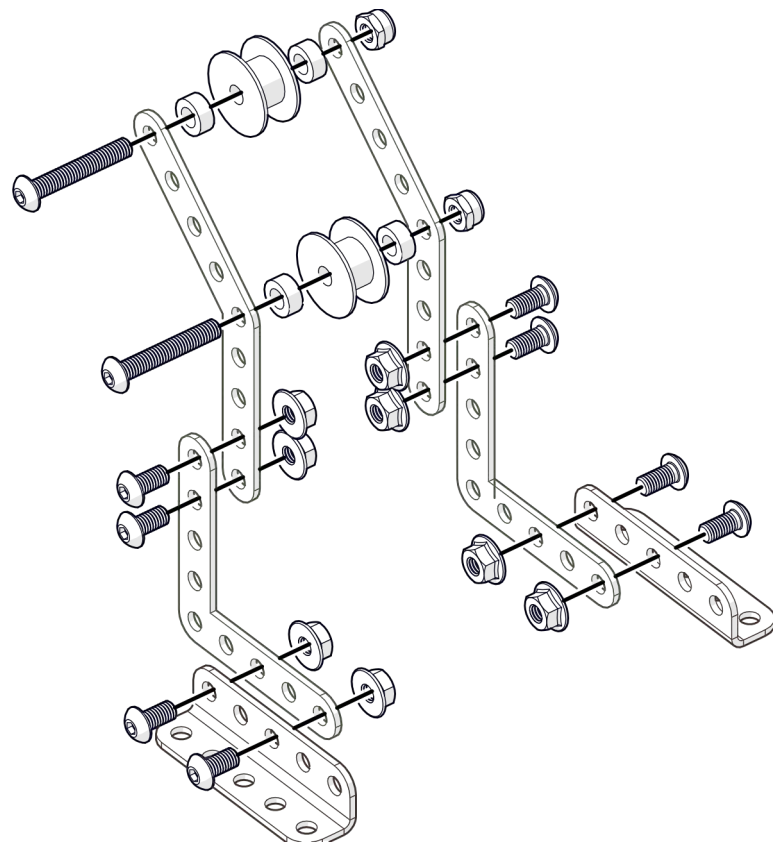

2x

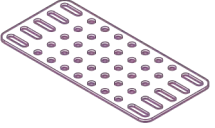

2

				
1x	4x	4x	4x	8x

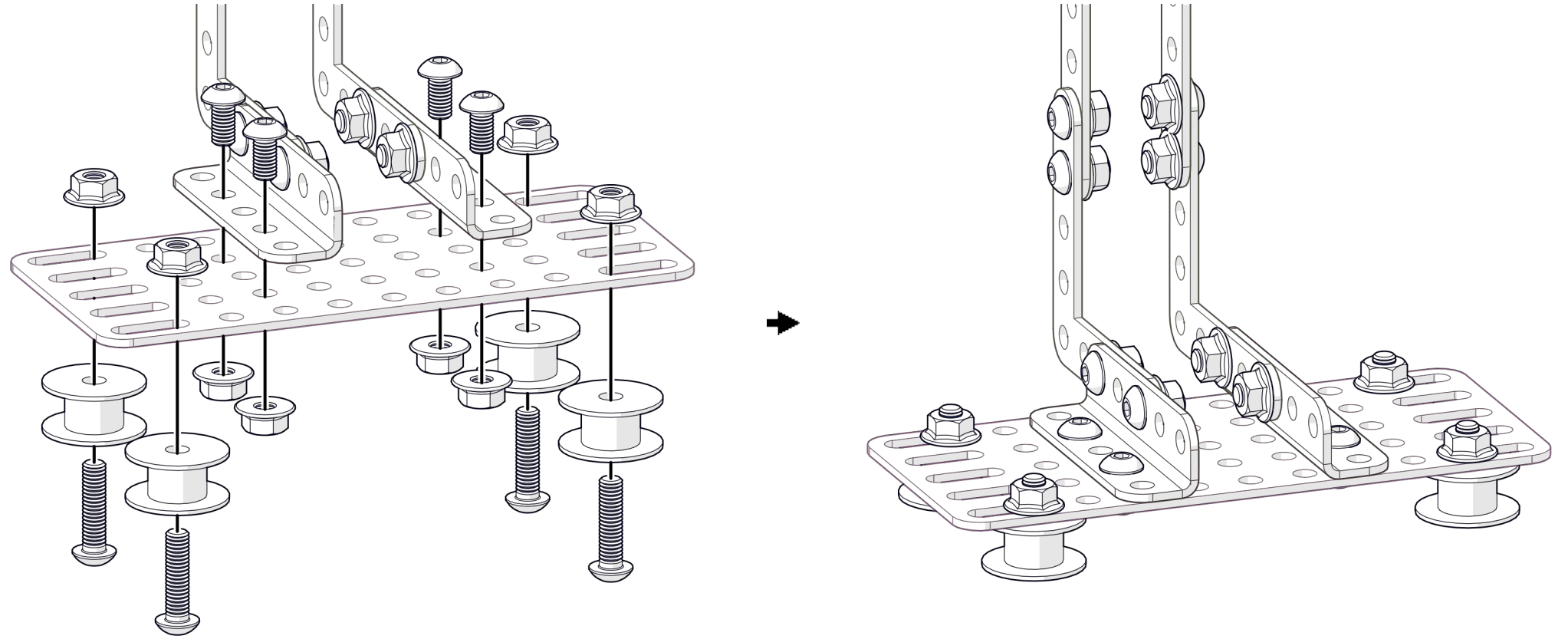

НАУЧИМ ИЗОБРЕТАТЬ
БУДУЩЕЕ

TRIK

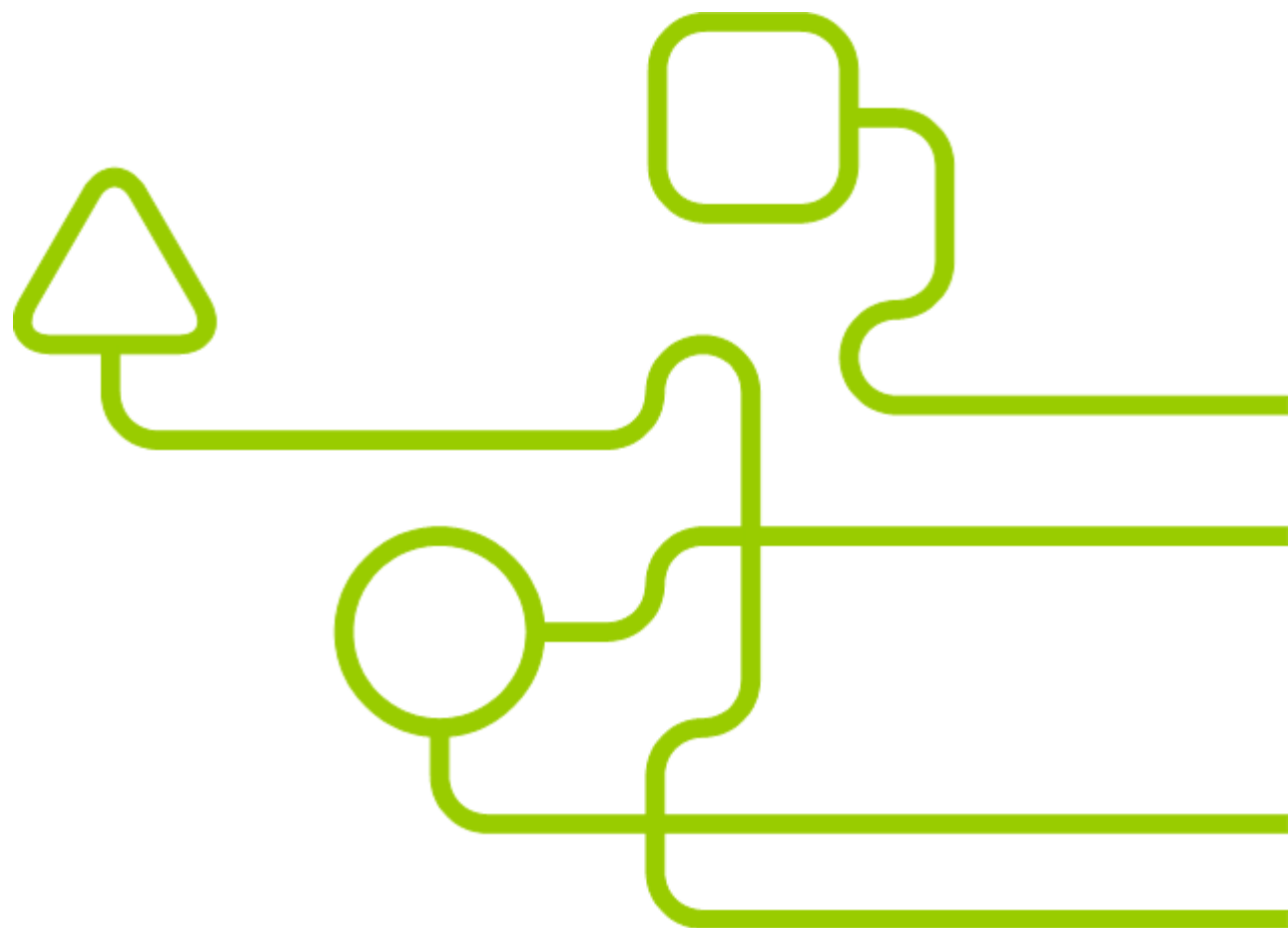

[trikset](#)

trikset.com

support@trikset.com

