

НАУЧИМ ИЗОБРЕТАТЬ
БУДУЩЕЕ

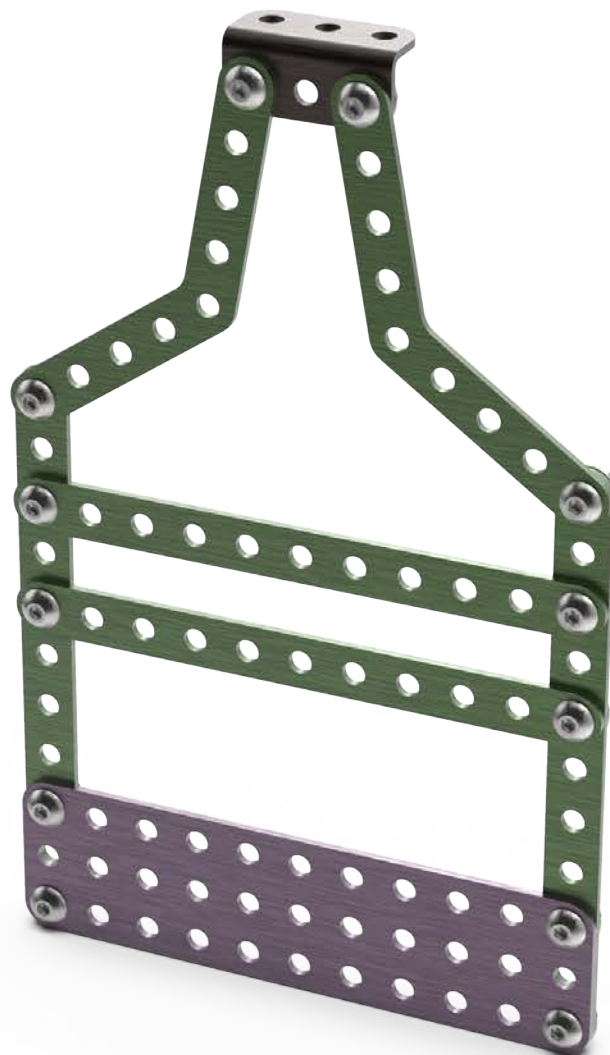

TRIK



Бутылка

Инструкция по сборке

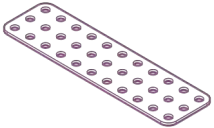
Перечень деталей

Название детали	Изображение	Количество (шт.)
Пластина 1x11		4
Пластина 3x11		1
Угол плоский 135° 5x5		2
Угол (1_1)x3		1
Винт М4х8	 M4x8	12
Гайка М4 фланцевая		12

1

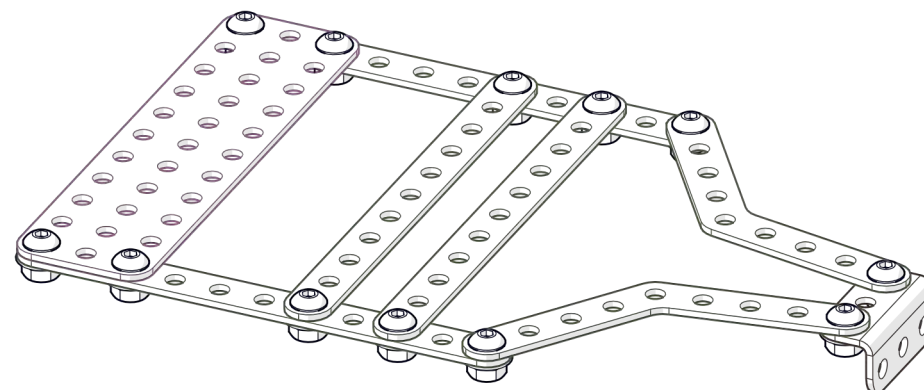
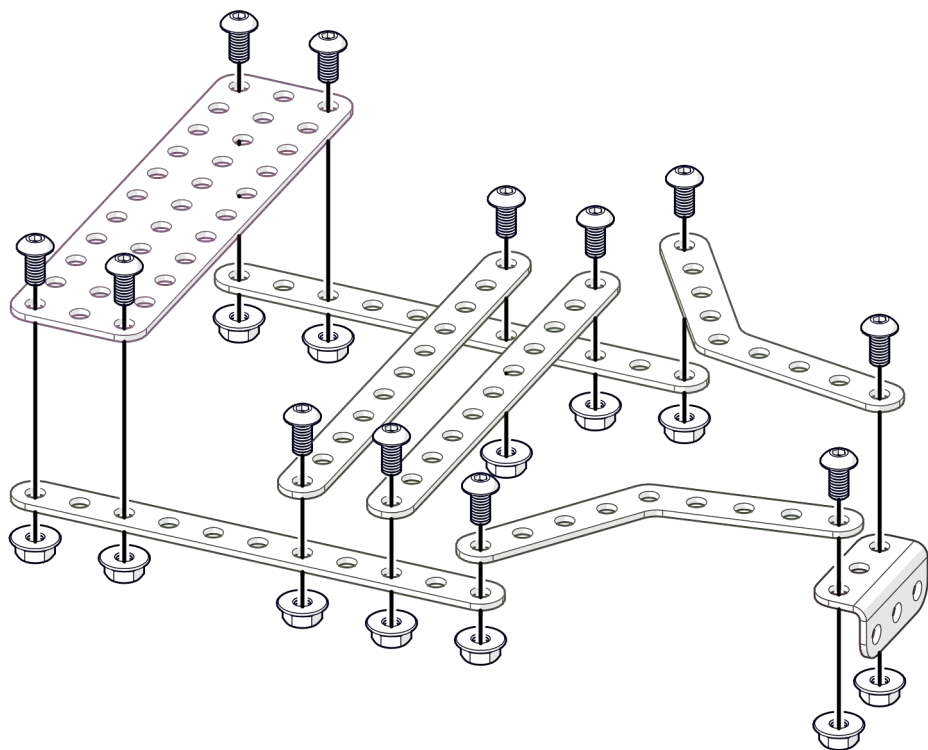
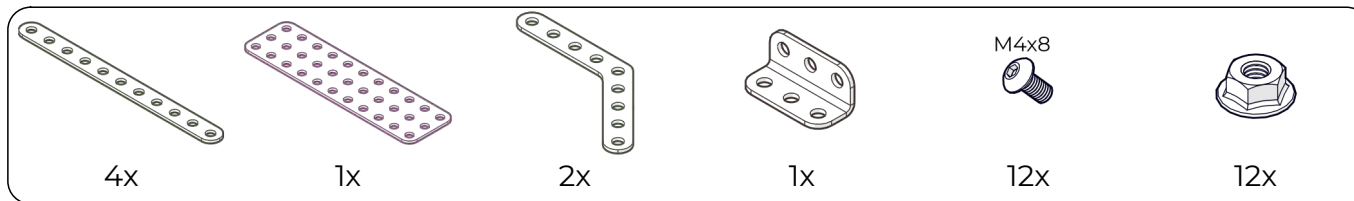

НАУЧИМ ИЗОБРЕТАТЬ
БУДУЩЕЕ

TRIK

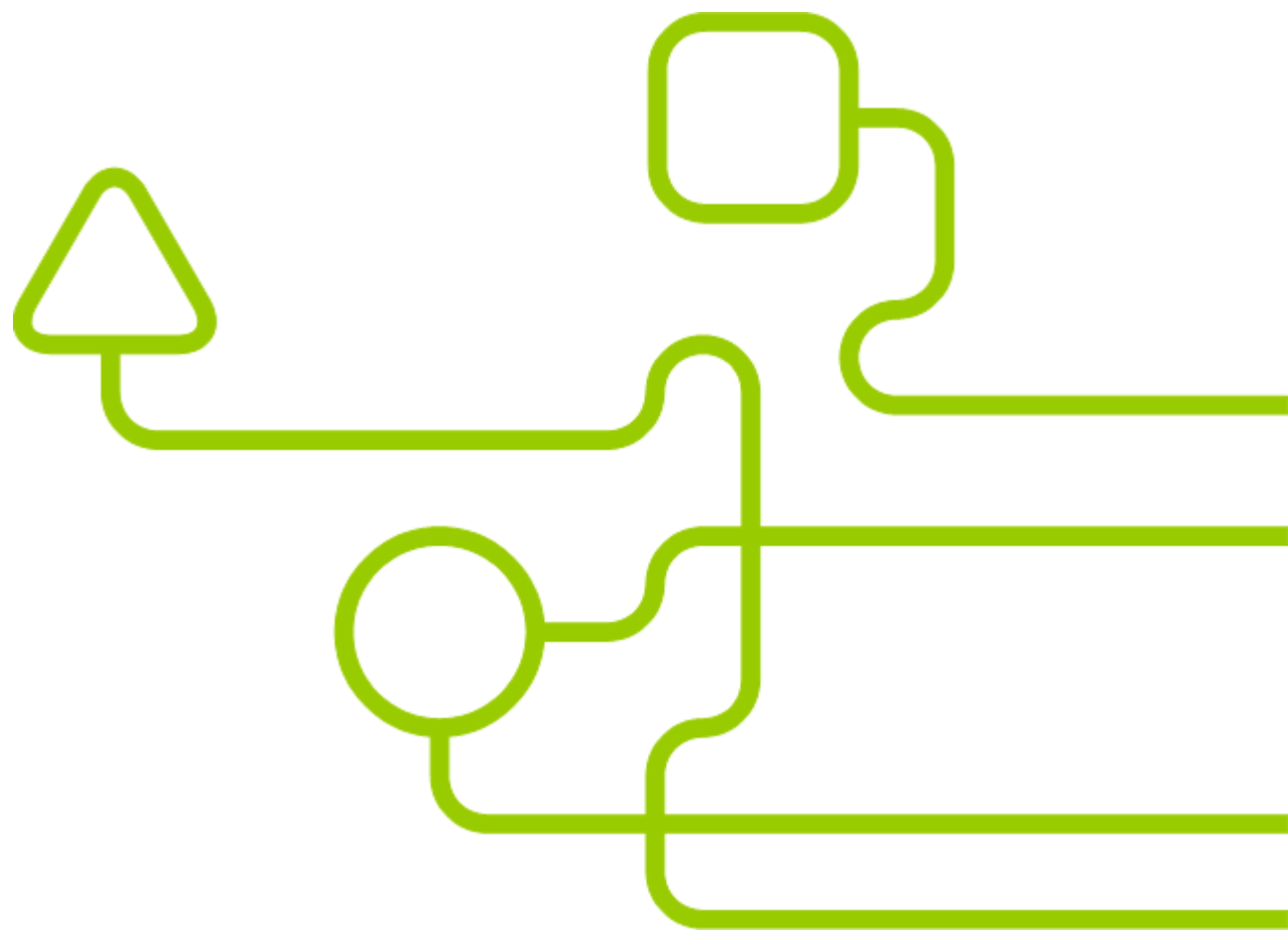

[trikset](#)

[trikset.com](#)

support@trikset.com

