

НАУЧИМ ИЗОБРЕТАТЬ  
БУДУЩЕЕ







TRIK

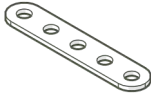

ДОМИК

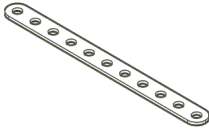
Инструкция по сборке

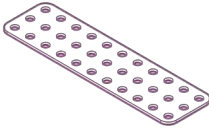
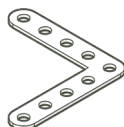
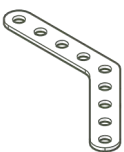
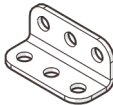
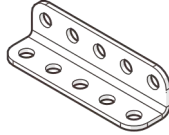
## Перечень деталей

Название детали	Изображение	Количество (шт.)	Название детали	Изображение	Количество (шт.)
Пластина 1x5		2	Гайка М4 фланцевая		24
Пластина 1x11		4	Шайба нейлоновая		2
Пластина 3x11		2			
Угол плоский 90° 5x5		2			
Угол плоский 135° 5x5		2			
Угол (1_1)x3		2			
Угол (1_1)x5		4			
Винт М4x8		24			

1

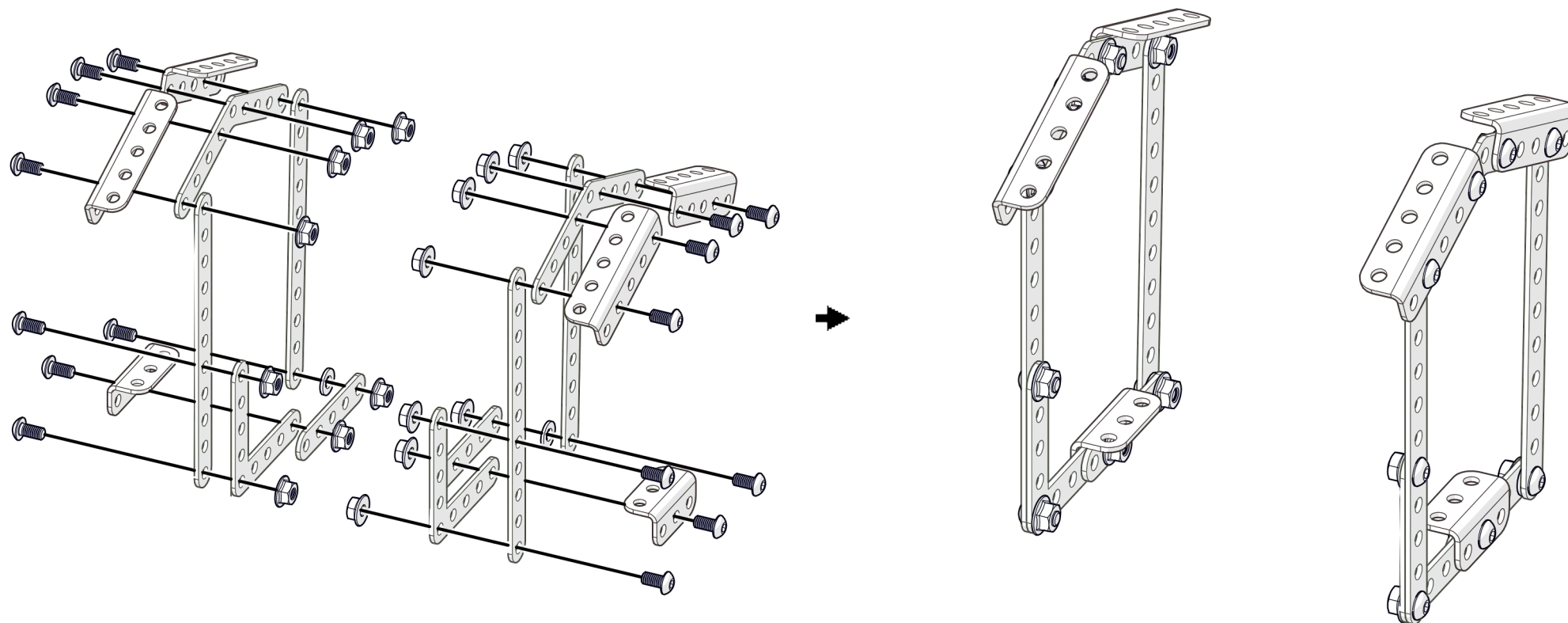
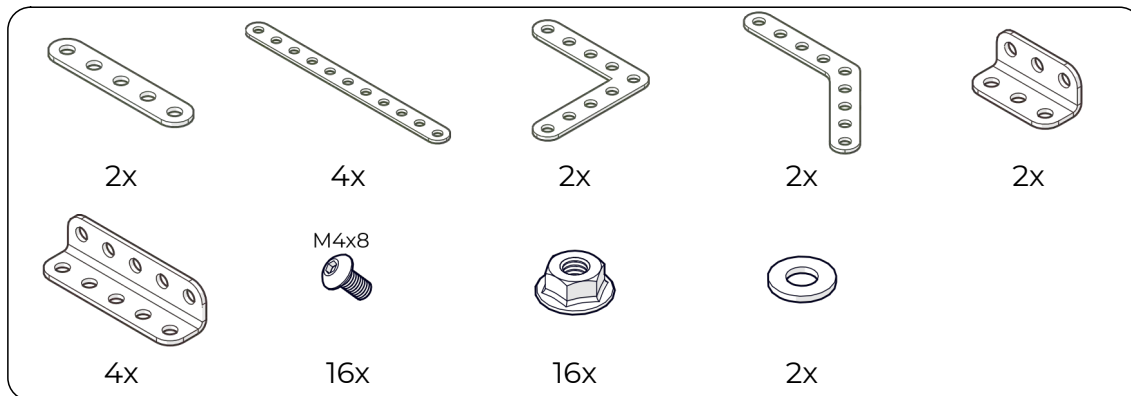

2

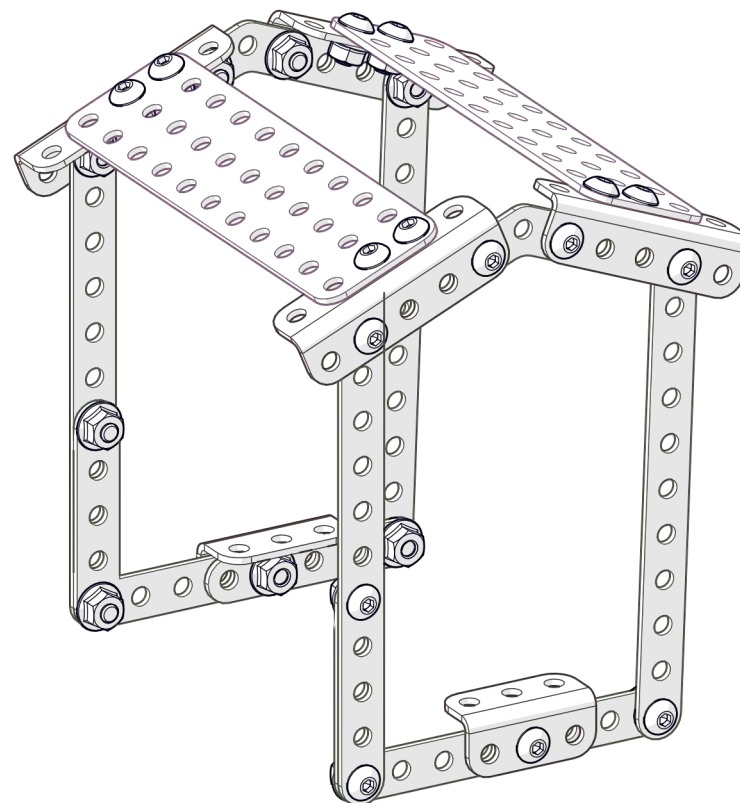
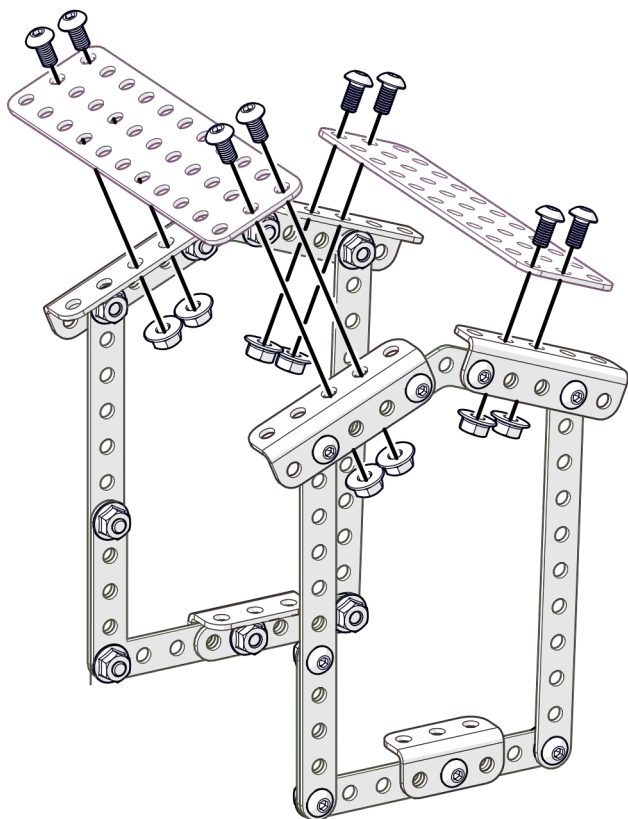
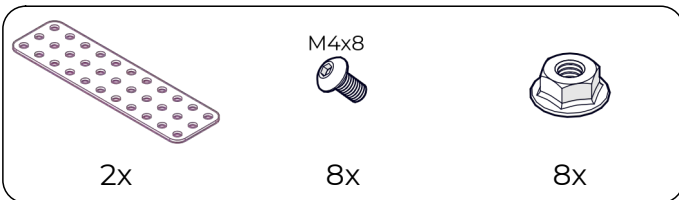

НАУЧИМ ИЗОБРЕТАТЬ  
БУДУЩЕЕ

TRIK

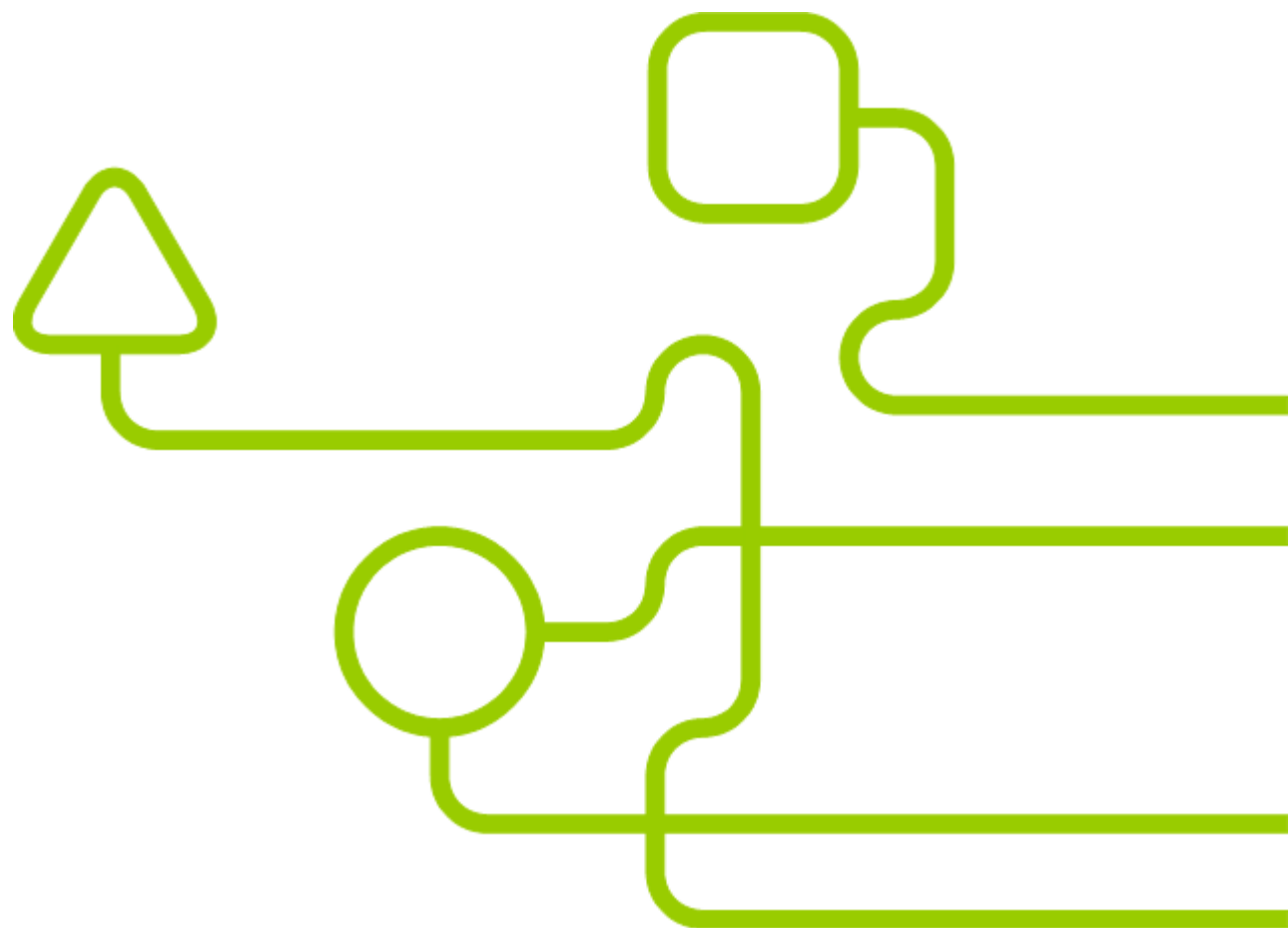

[trikset](#)

[trikset.com](http://trikset.com)

[support@trikset.com](mailto:support@trikset.com)

