

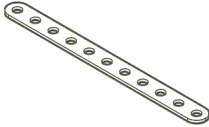









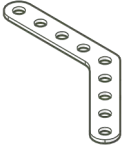

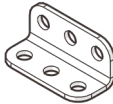

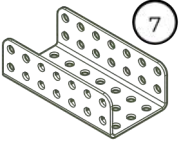

# Магнитная тележка

Инструкция по сборке

## Перечень деталей

Название детали	Изображение	Количество (шт.)	Название детали	Изображение	Количество (шт.)
Пластина 1x11		2	Гайка М4 стопорная		5
Угол плоский 135° 5x5		1	Шайба нейлоновая		1
Угол (1_1)x3		1	Кольцо 3.4 мм		2
Балка (2_3_2)x7		1	Кольцо 5 мм		1
Винт М4x8	 M4x8	6	Магнит		2
Винт М4x16	 M4x16	6	Планшайба		1
Винт М4x25	 M4x25	1	Шкив		4
Гайка М4 фланцевая		8			

1

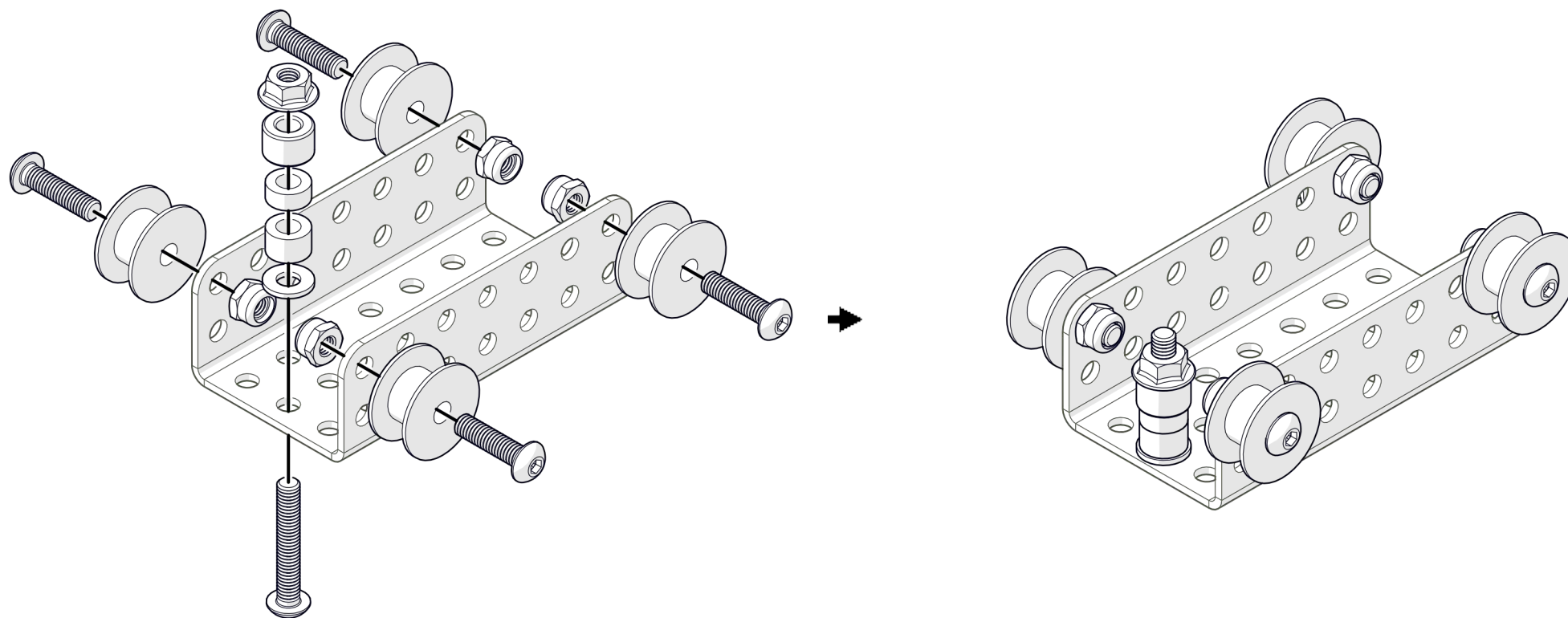
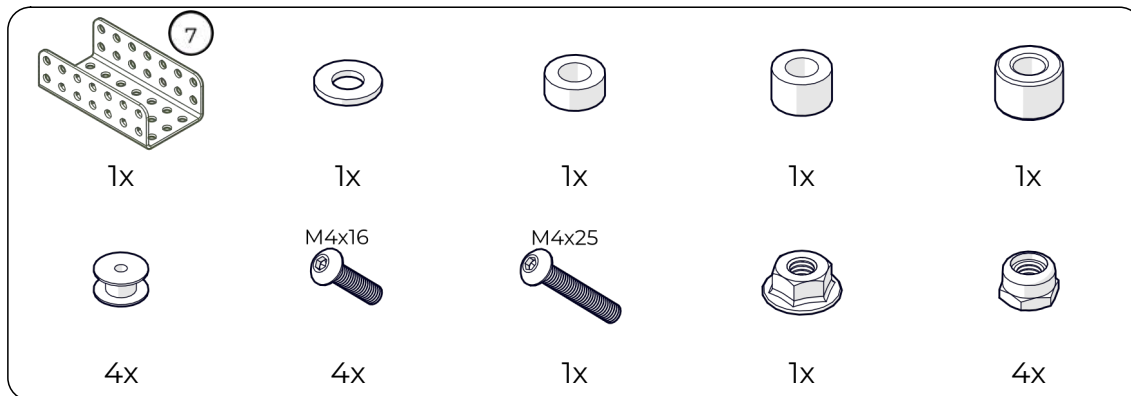

2

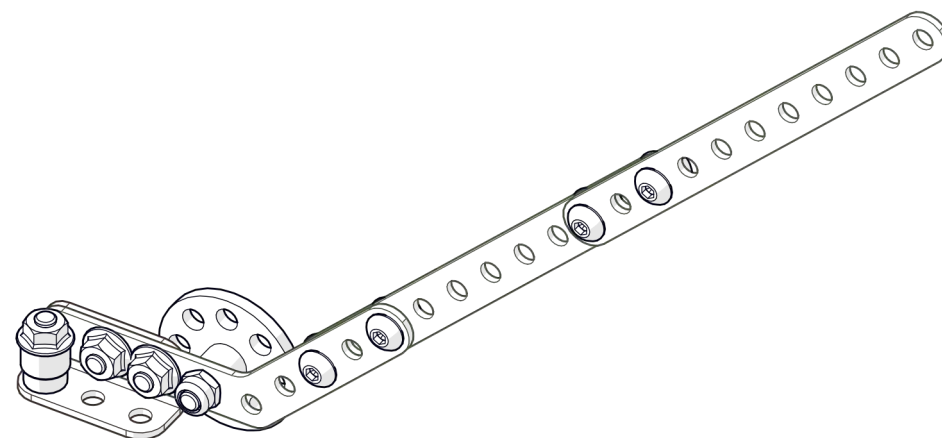
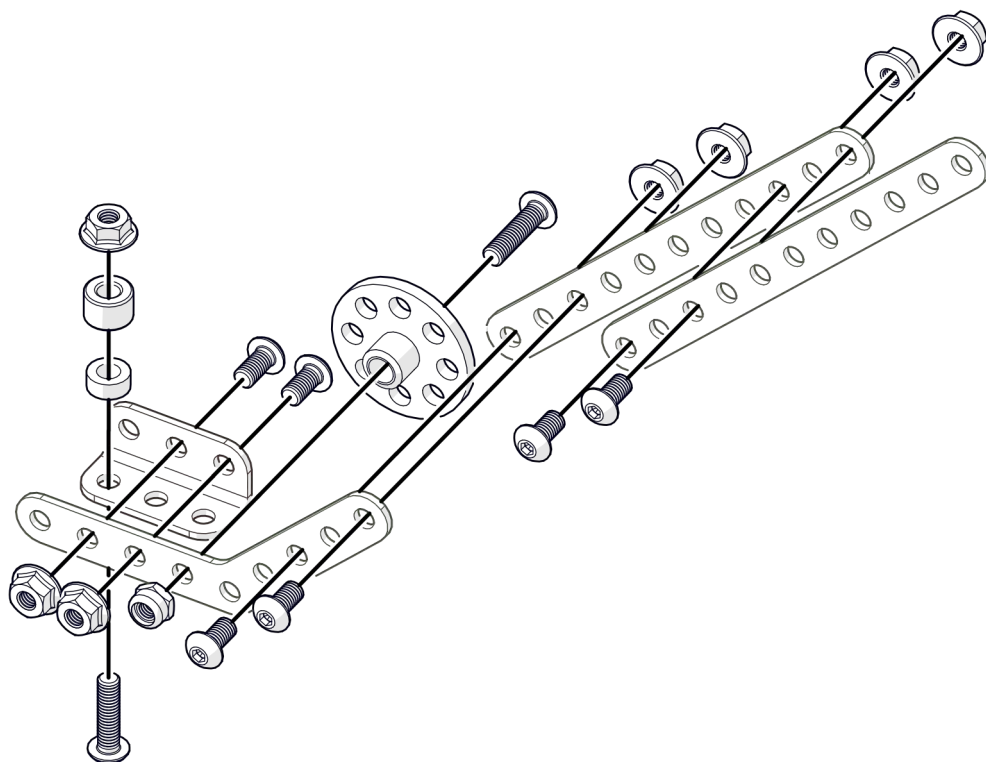
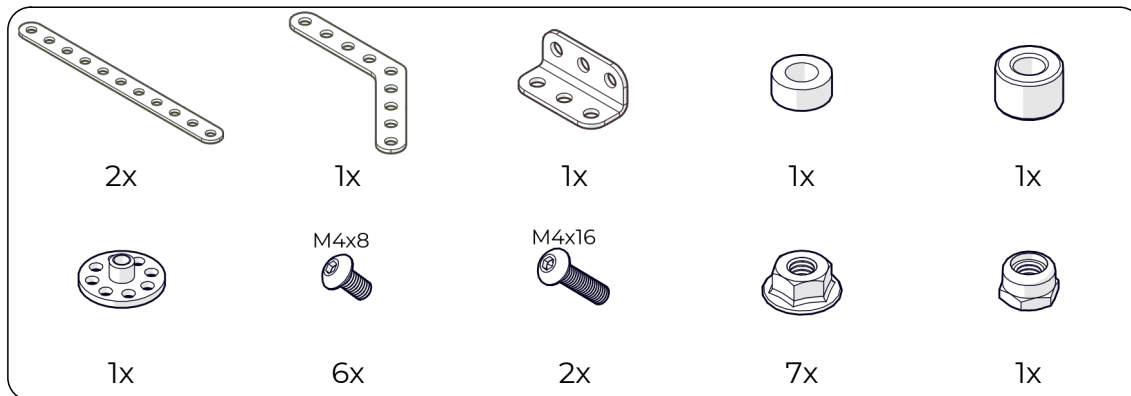

НАУЧИМ ИЗОБРЕТАТЬ  
БУДУЩЕЕ

TRIK

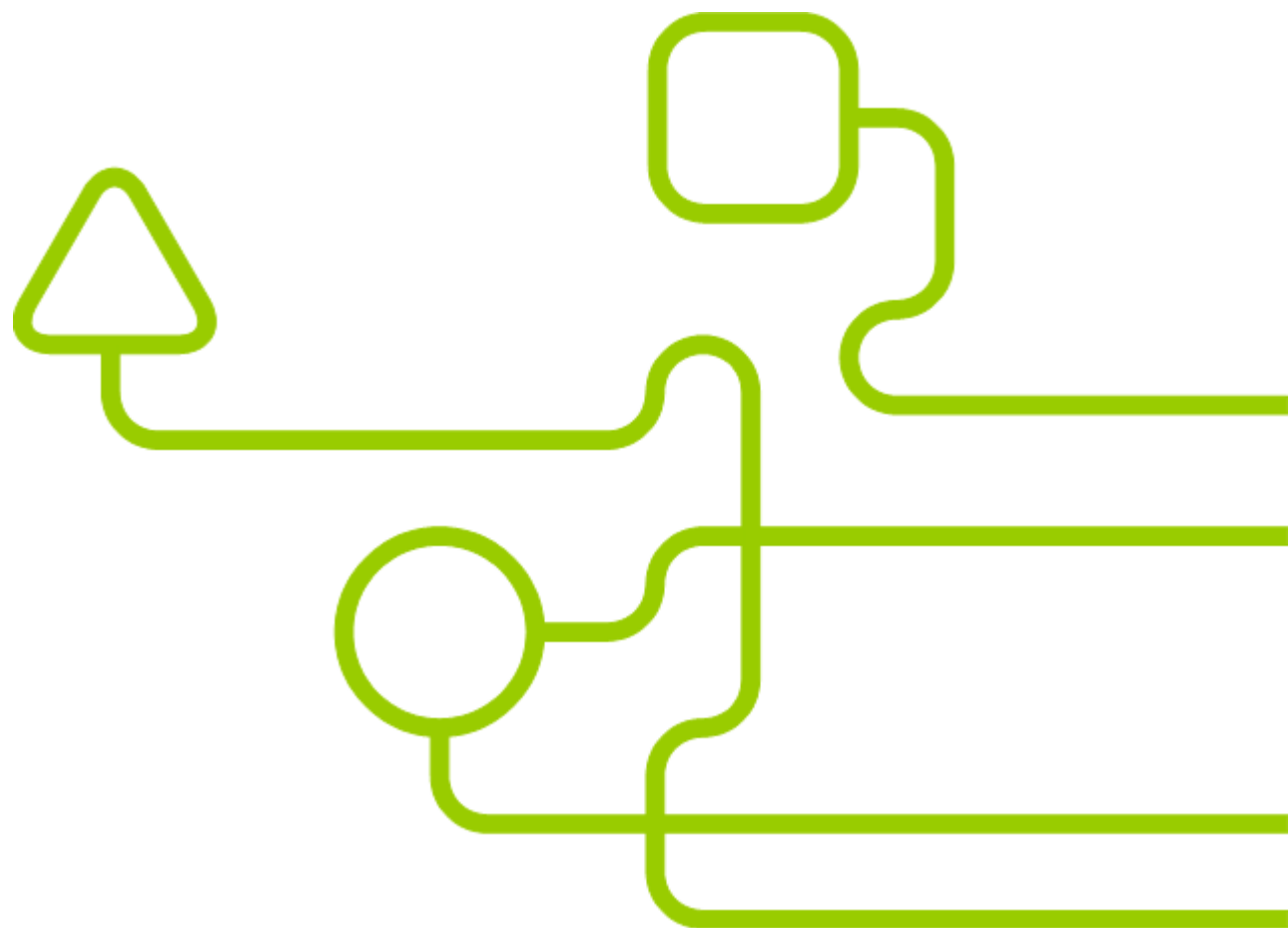

[trikset](#)

[trikset.com](#)

[support@trikset.com](mailto:support@trikset.com)

