

НАУЧИМ ИЗОБРЕТАТЬ
БУДУЩЕЕ











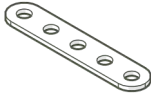

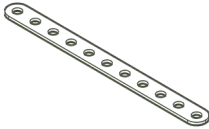
TRIK

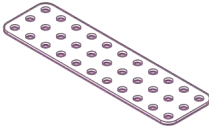

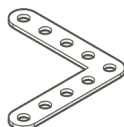
Марионетка лошадка

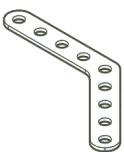
Инструкция по сборке

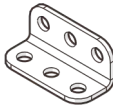
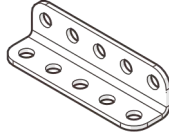
Перечень деталей

Название детали	Изображение	Количество (шт.)	Название детали	Изображение	Количество (шт.)
Пластина 1x5		2	Винт М4x16		2
Пластина 1x11		2	Гайка М4 фланцевая		15
Пластина 3x11		2	Гайка М4 стопорная		2
Угол плоский 90° 5x5		3	Кольцо 3.4 мм		4
Угол плоский 135° 5x5		2	Катушка с нитью 3 м		1
Угол (1_1)x3		1			
Угол (1_1)x5		3			
Винт М4x8		15			

1

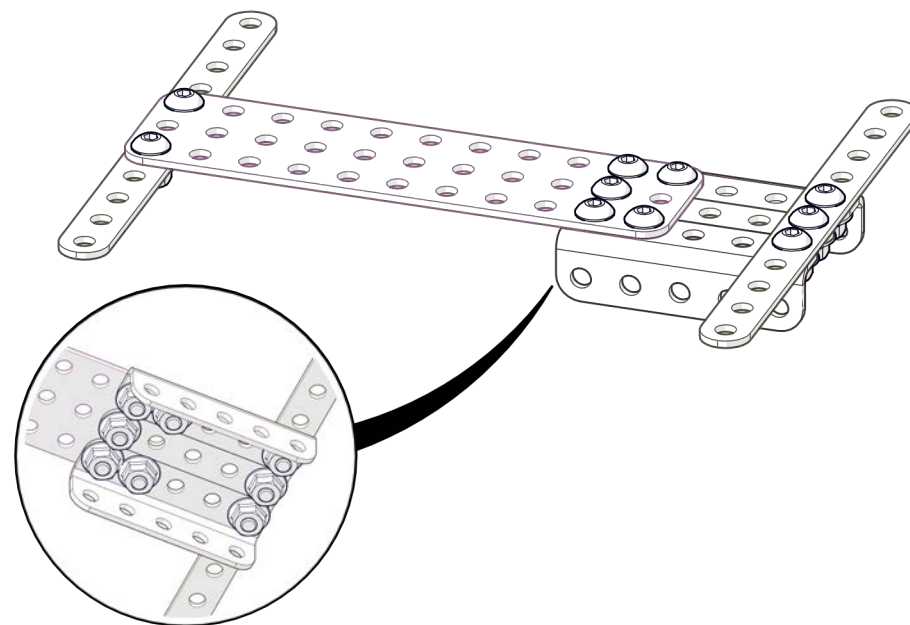
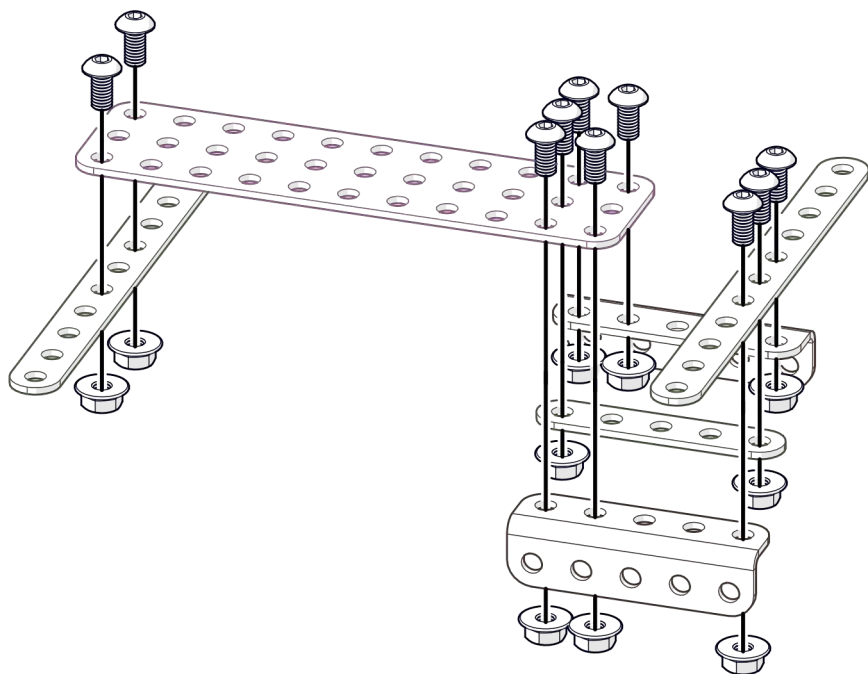
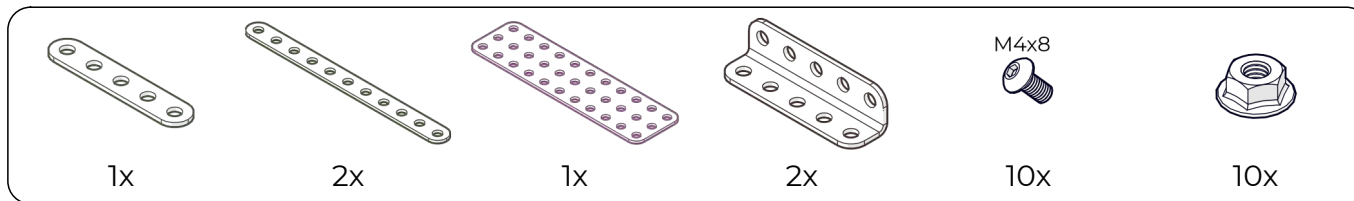

2

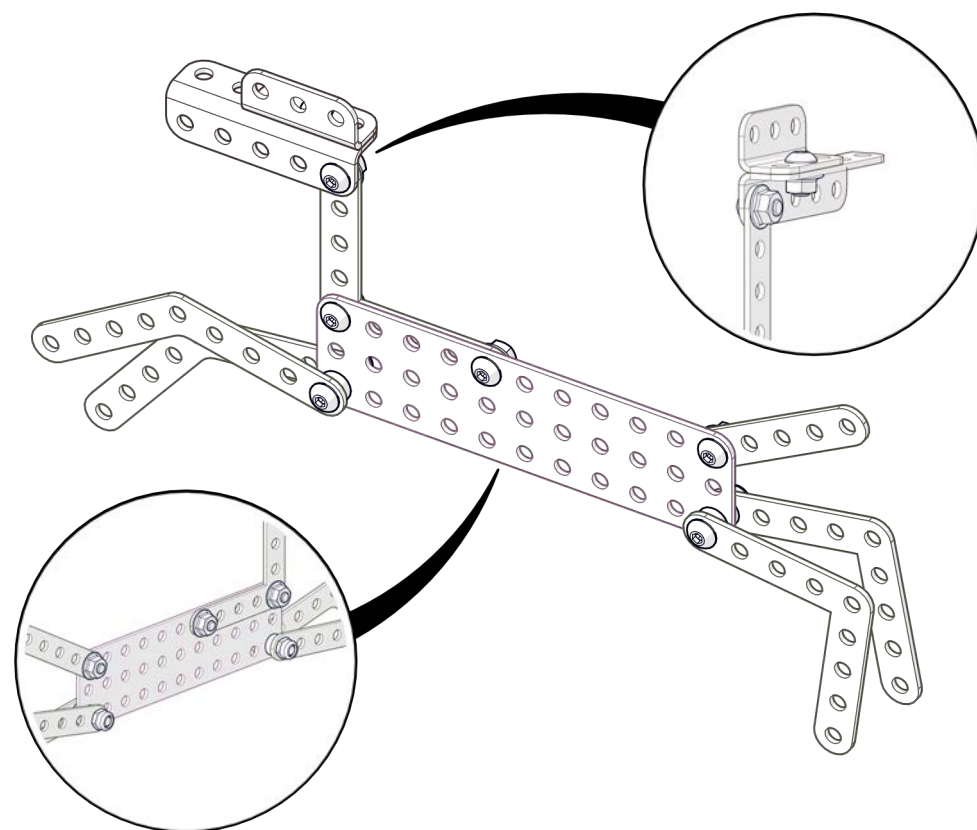
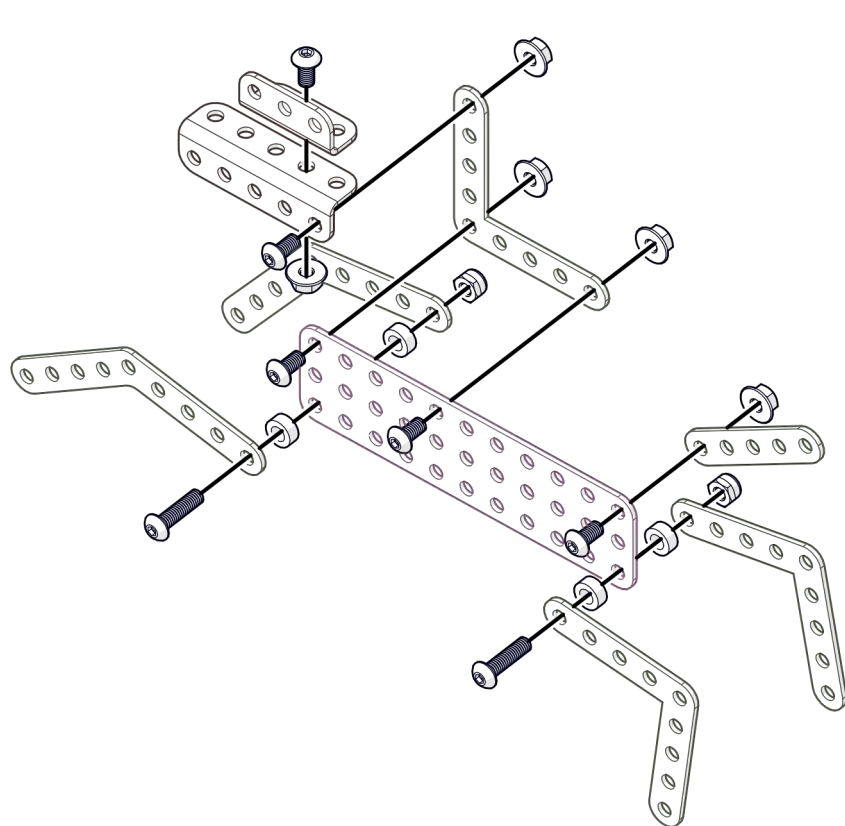
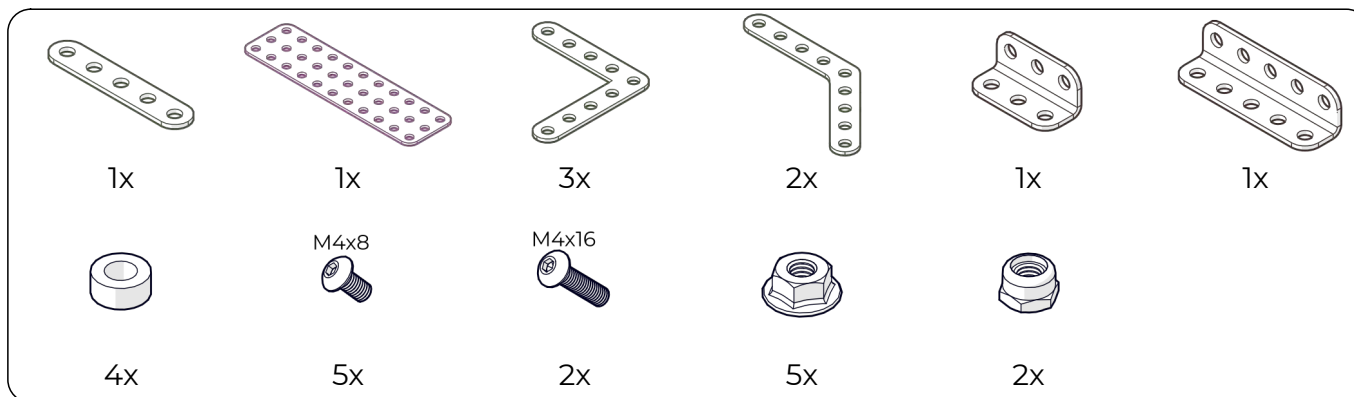

3



1x

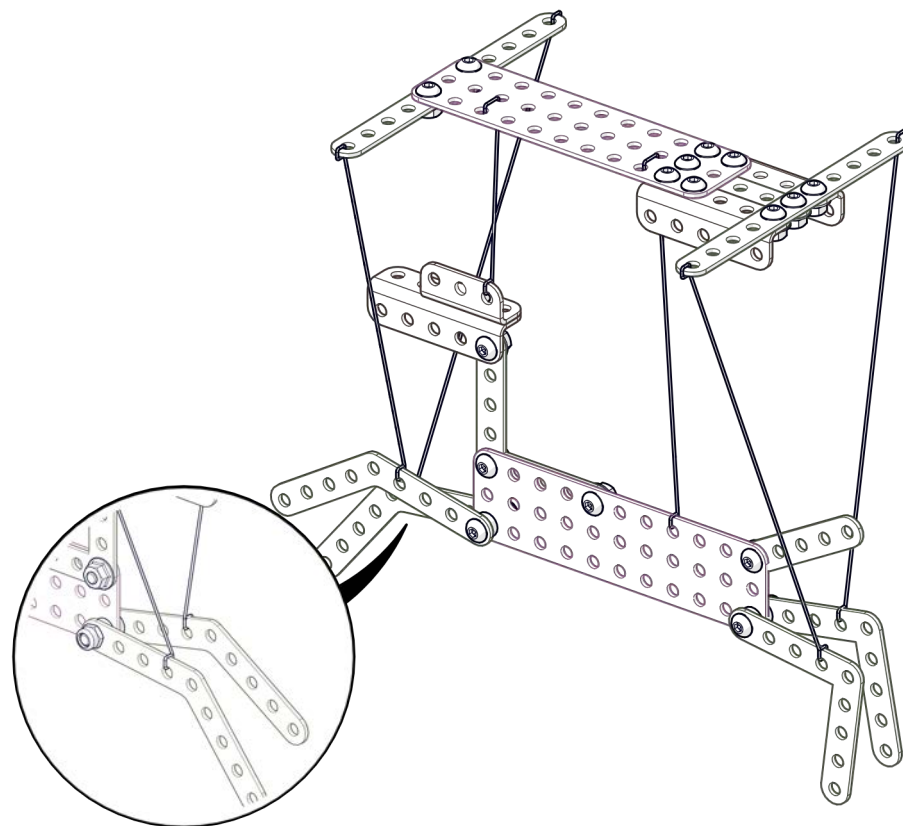

НАУЧИМ ИЗОБРЕТАТЬ
БУДУЩЕЕ

TRIK



[trikset](#)

trikset.com

support@trikset.com

