

НАУЧИМ ИЗОБРЕТАТЬ
БУДУЩЕЕ











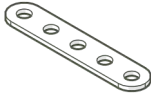

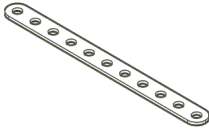

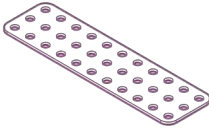
TRIK

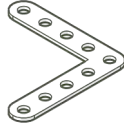

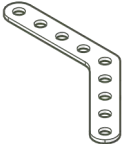
Марионетка страус

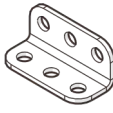
Инструкция по сборке

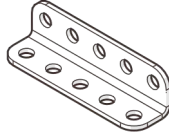
Перечень деталей

Название детали	Изображение	Количество (шт.)	Название детали	Изображение	Количество (шт.)
Пластина 1x5		3	Винт М4х16		1
Пластина 1x11		2	Гайка М4 фланцевая		13
Пластина 3x11		1	Гайка М4 стопорная		1
Угол плоский 90° 5x5		1	Кольцо 3.4 мм		2
Угол плоский 135° 5x5		2	Шарик деревянный 20 мм		1
Угол (1_1)x3		2	Катушка с нитью 3 м		1
Угол (1_1)x5		2			
Винт М4х8		14			

1

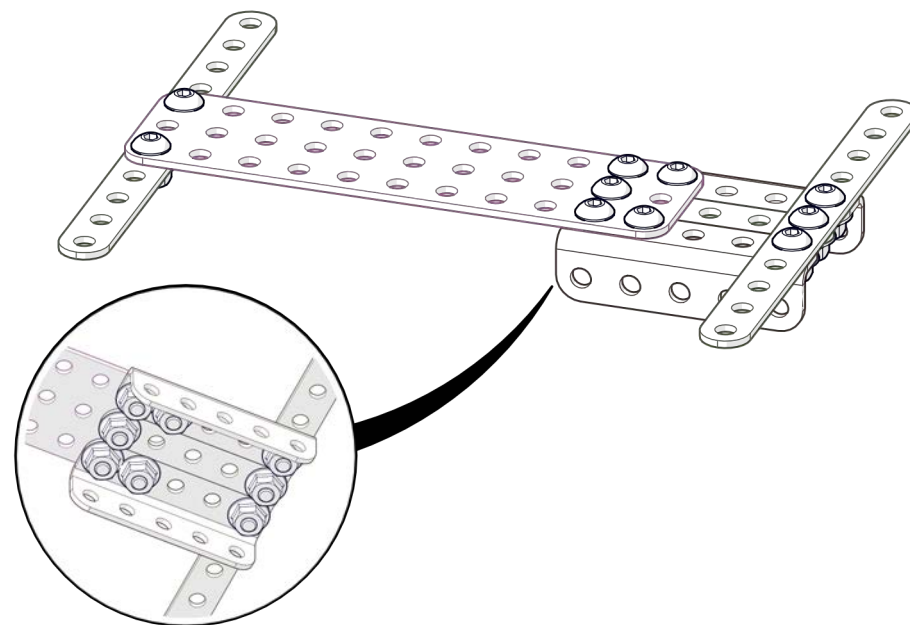
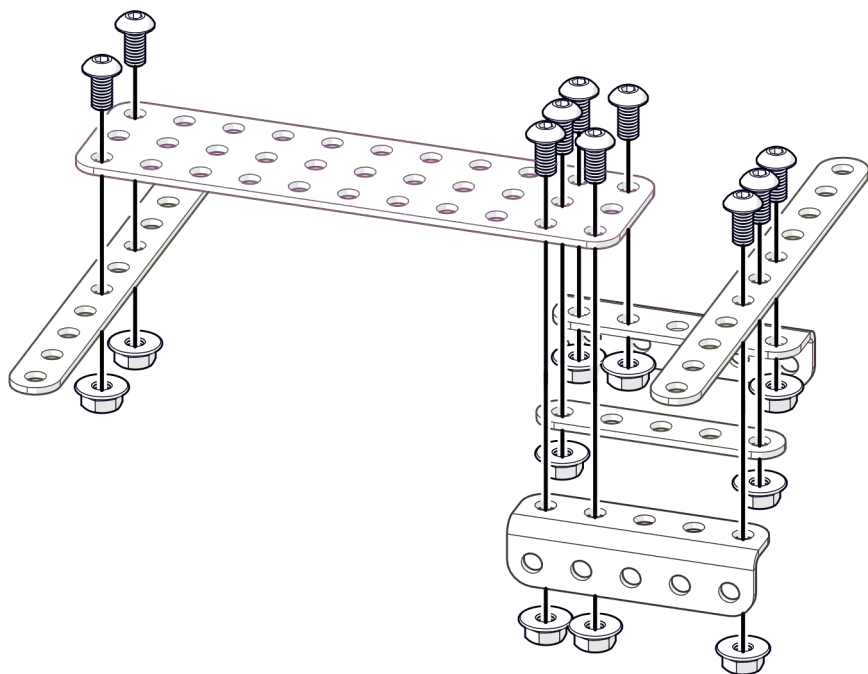
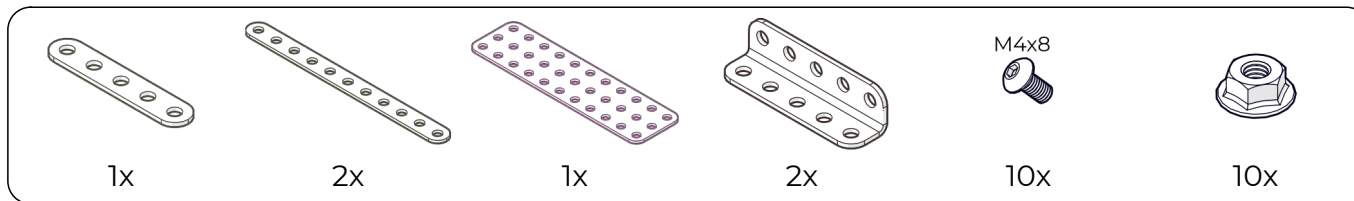

2

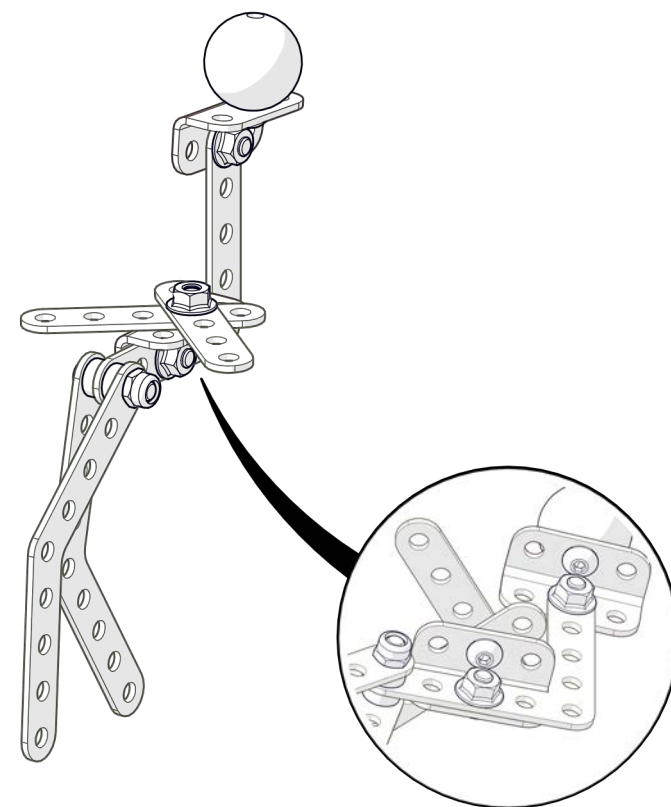
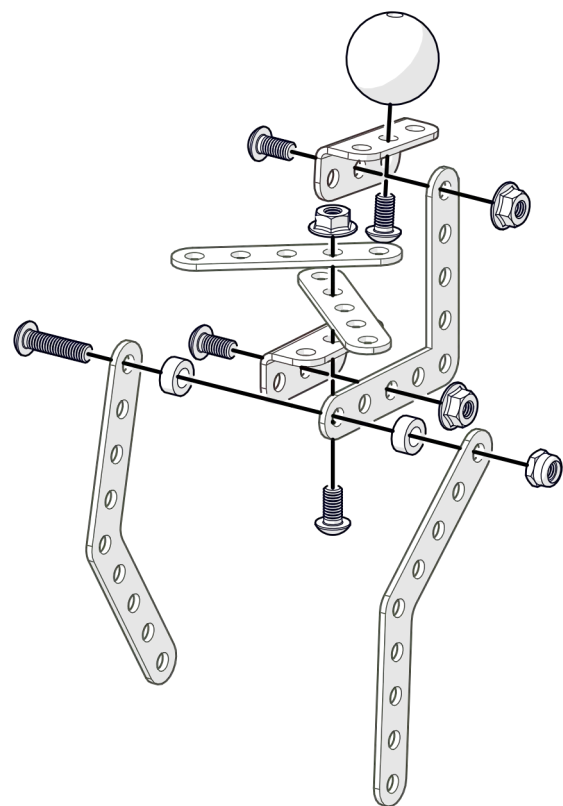
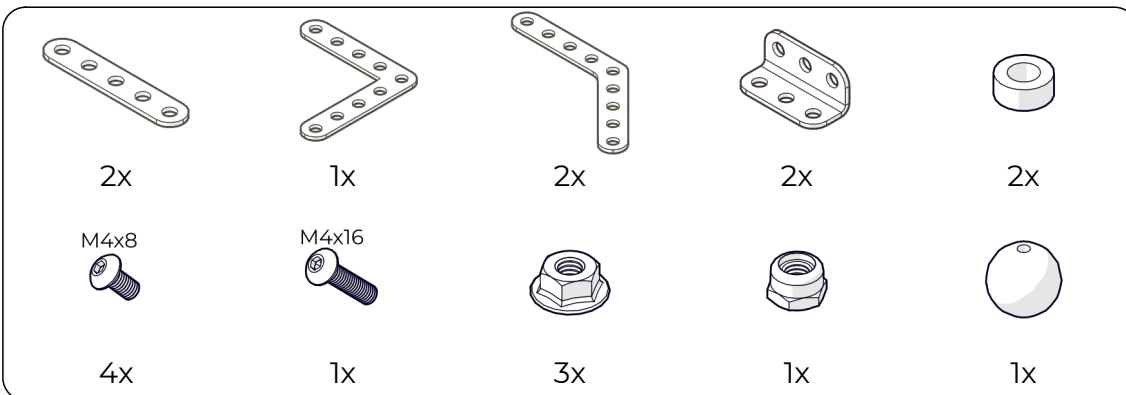

3

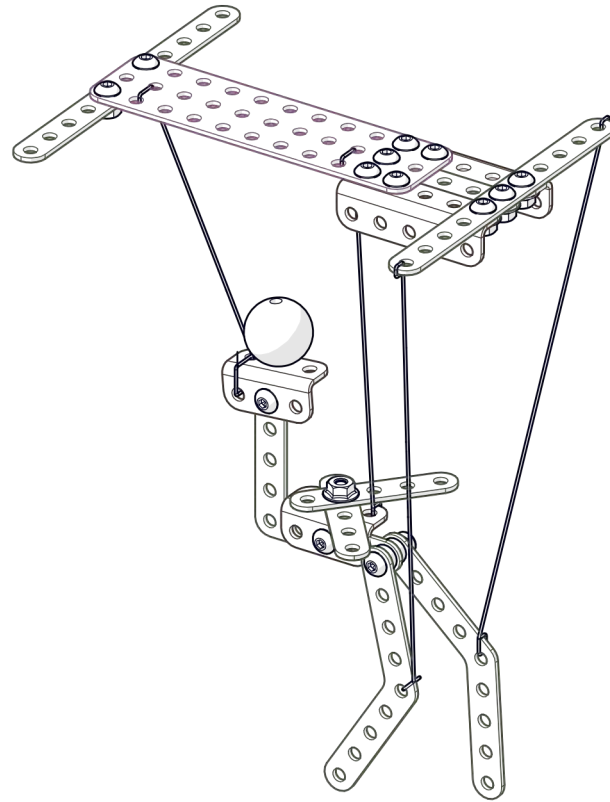
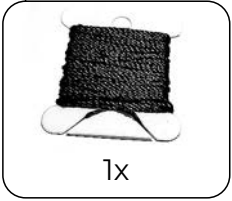

НАУЧИМ ИЗОБРЕТАТЬ
БУДУЩЕЕ

TRIK

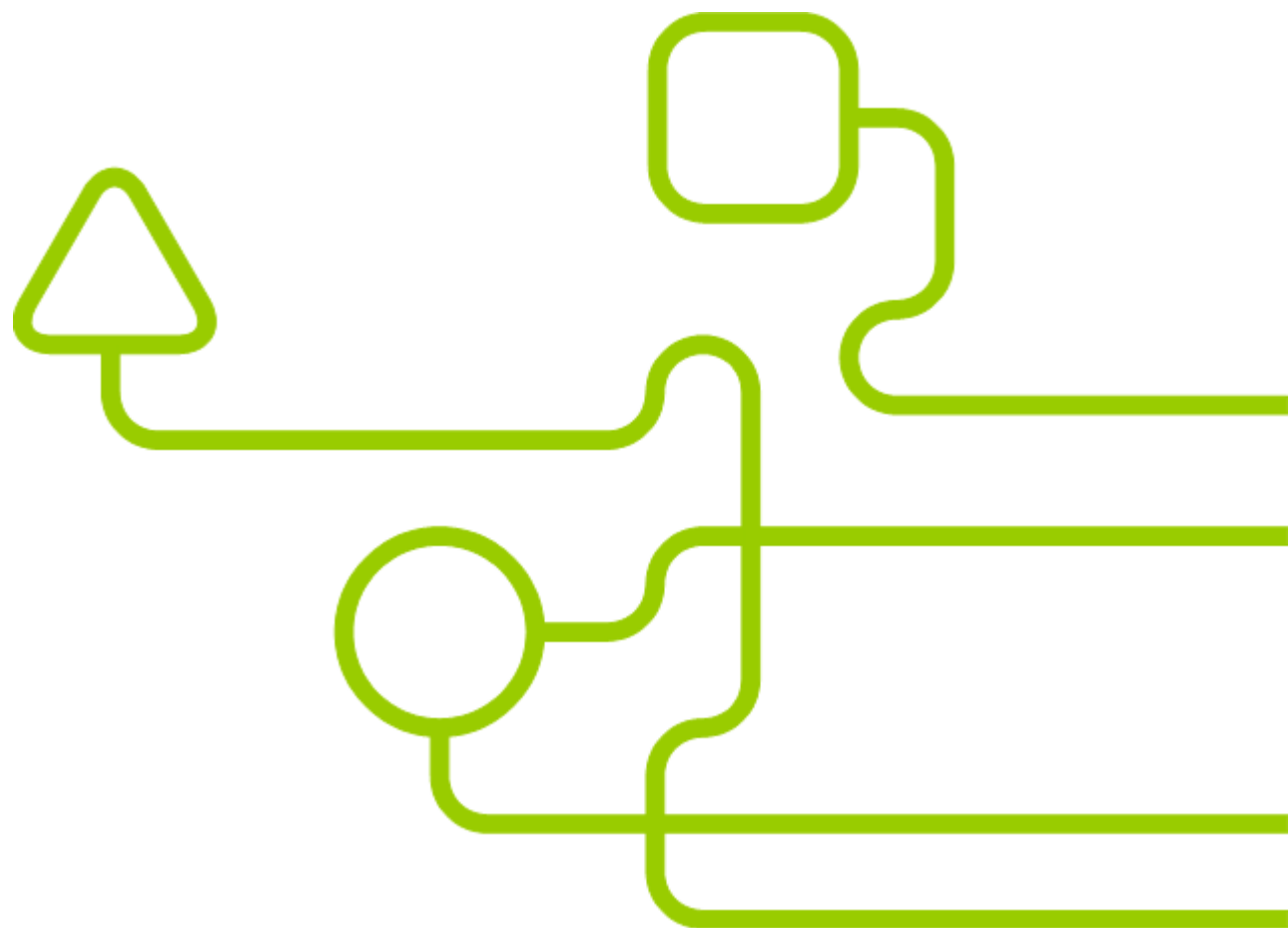

[trikset](#)

trikset.com

support@trikset.com

