

НАУЧИМ ИЗОБРЕТАТЬ
БУДУЩЕЕ

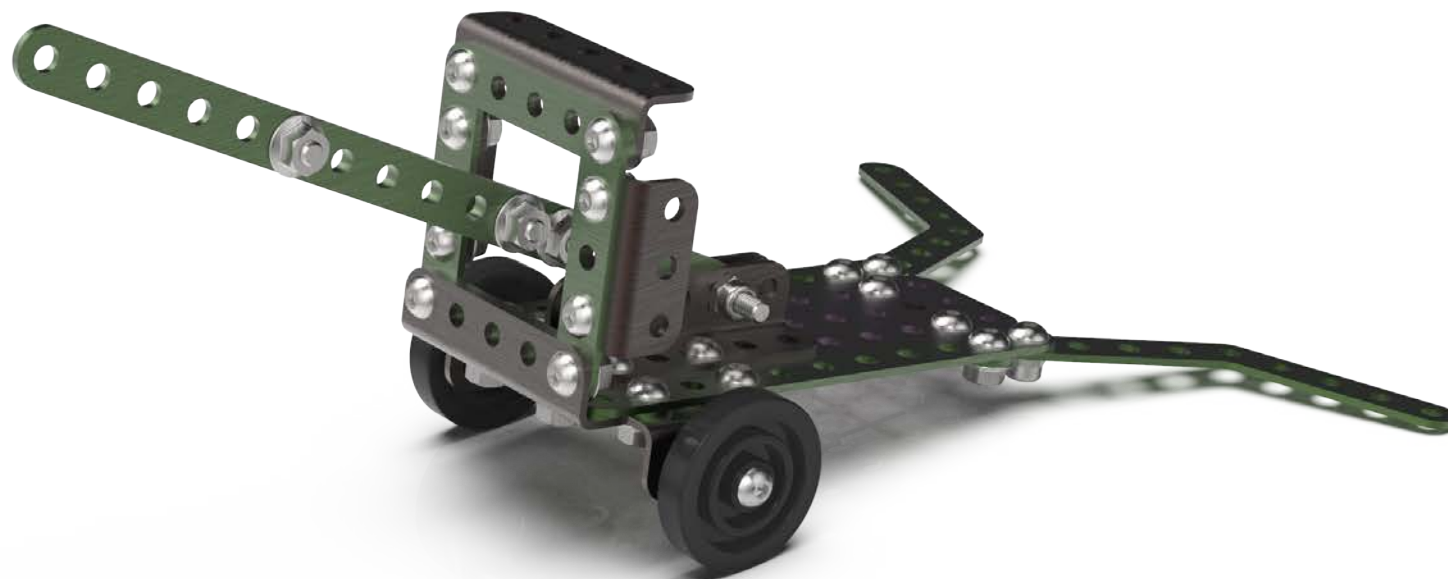







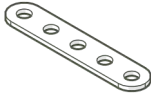

TRIK

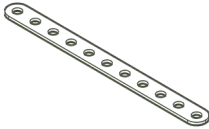

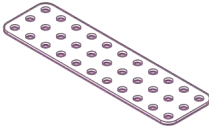

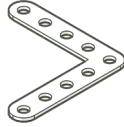

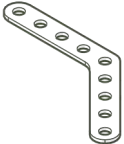
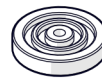
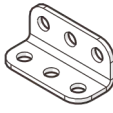
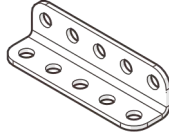

Пушка

Инструкция по сборке

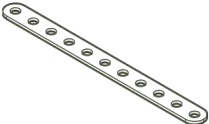
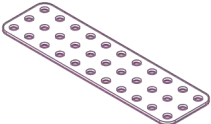
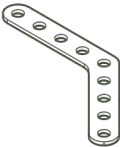
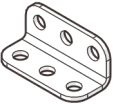
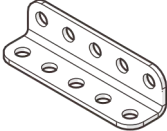
Перечень деталей

Название детали	Изображение	Количество (шт.)	Название детали	Изображение	Количество (шт.)
Пластина 1x5		4	Винт М4х16		3
Пластина 1x11		4	Гайка М4 фланцевая		25
Пластина 3x11		1	Гайка М4 стопорная		5
Угол плоский 90° 5x5		2	Кольцо 3.4 мм		2
Угол плоский 135° 5x5		2	Колесо		2
Угол (1_1)x3		4			
Угол (1_1)x5		4			
Винт М4х8		27			

1

					
3x	2x	1x	2x	2x	1x
					
12x	2x	10x	4x	2x	2x

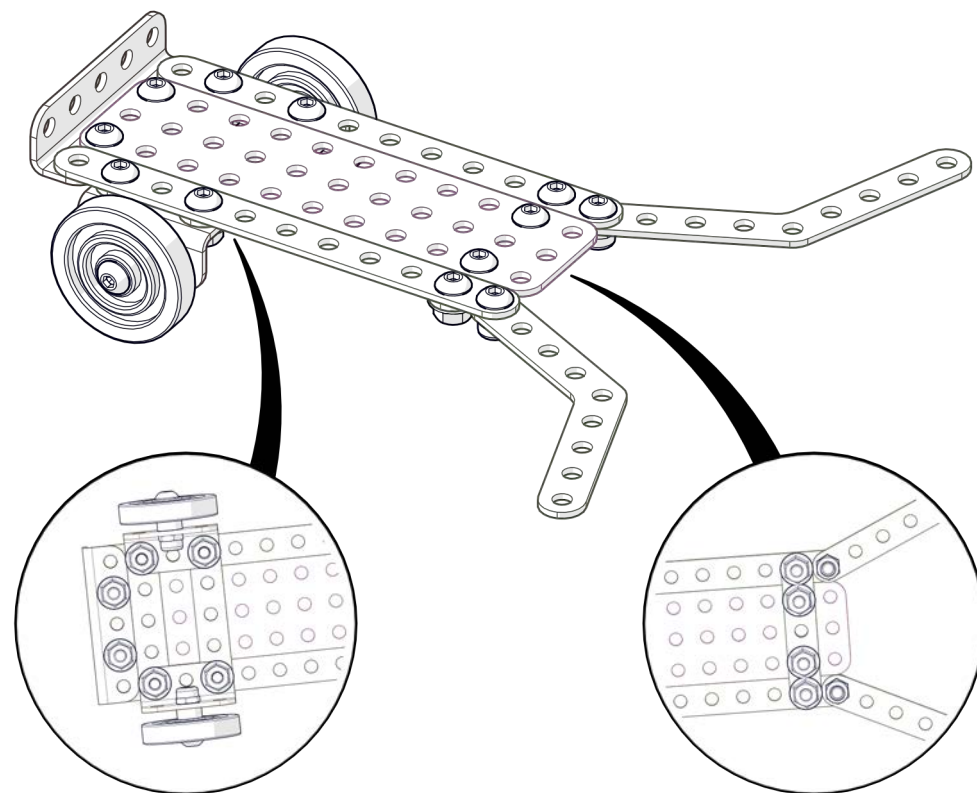
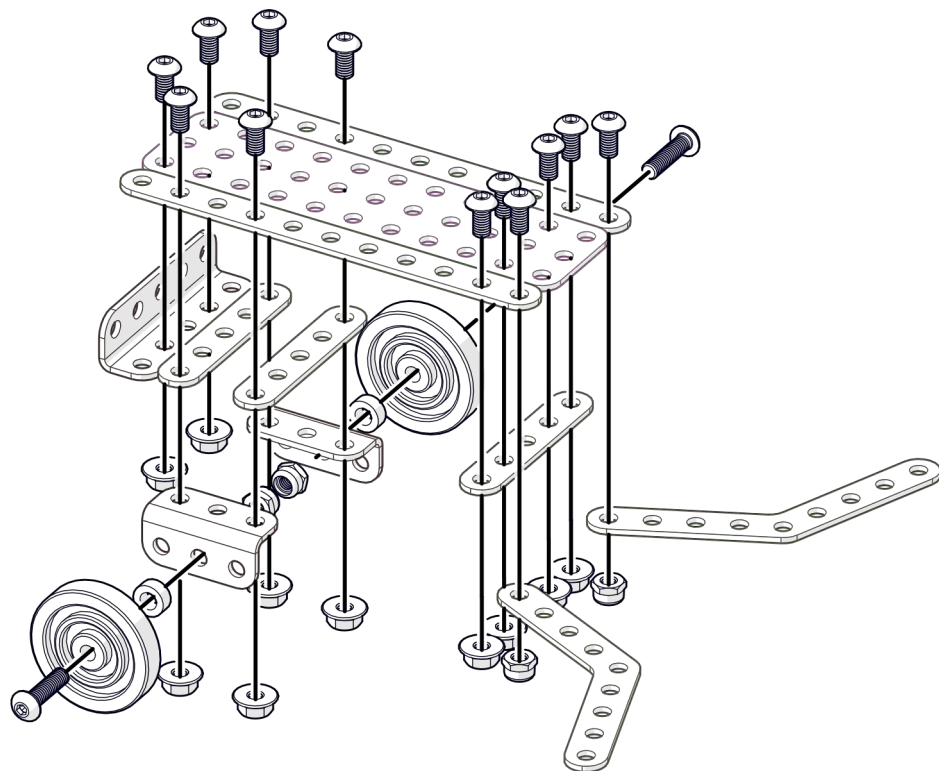

2

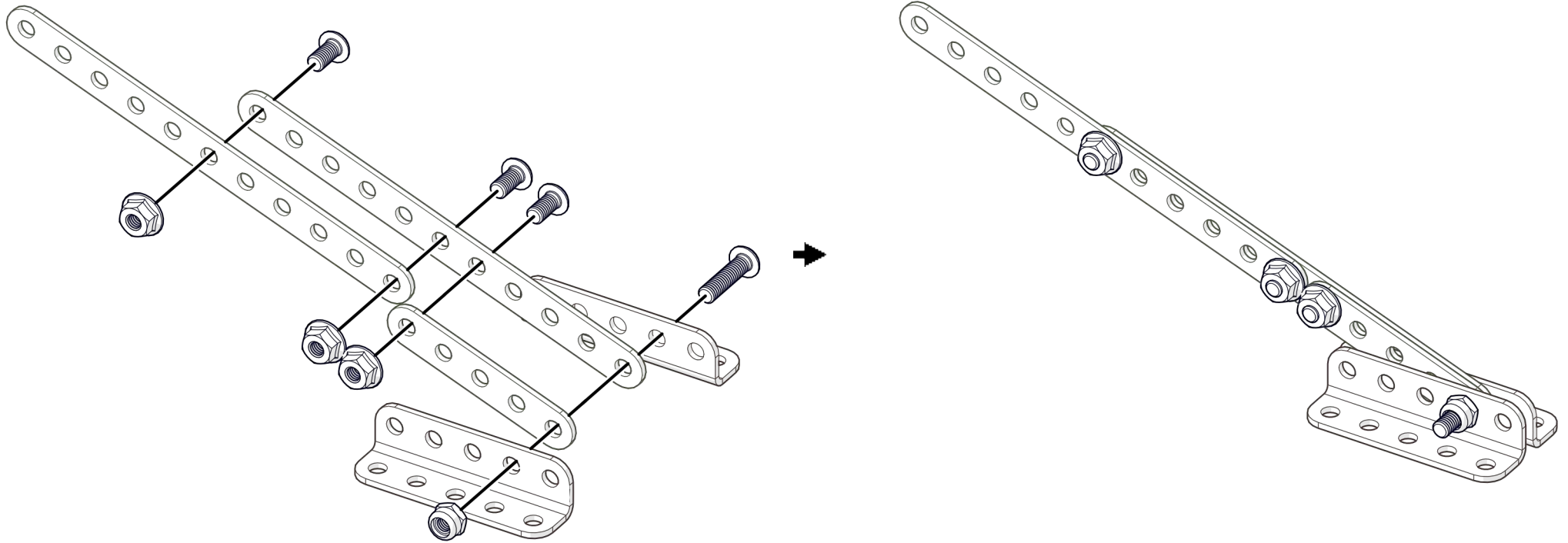
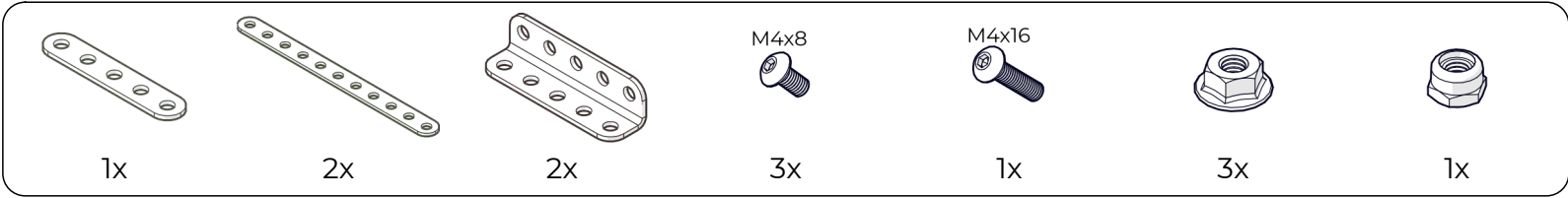

3

M4x8



4x



4x

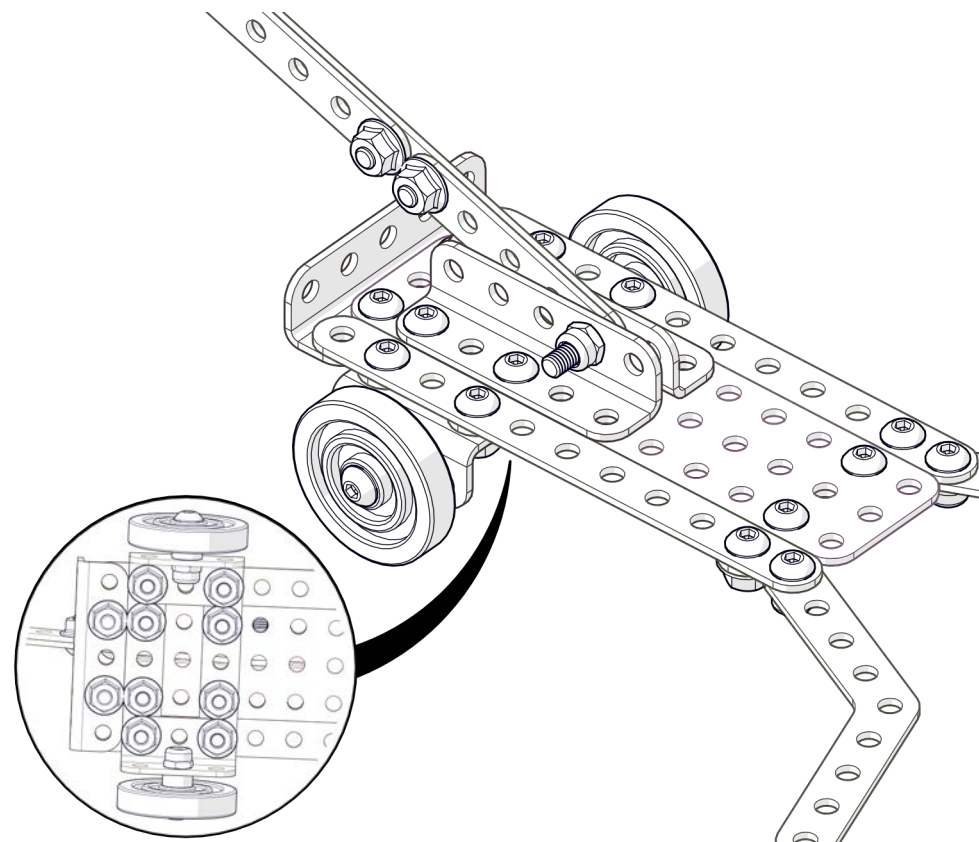
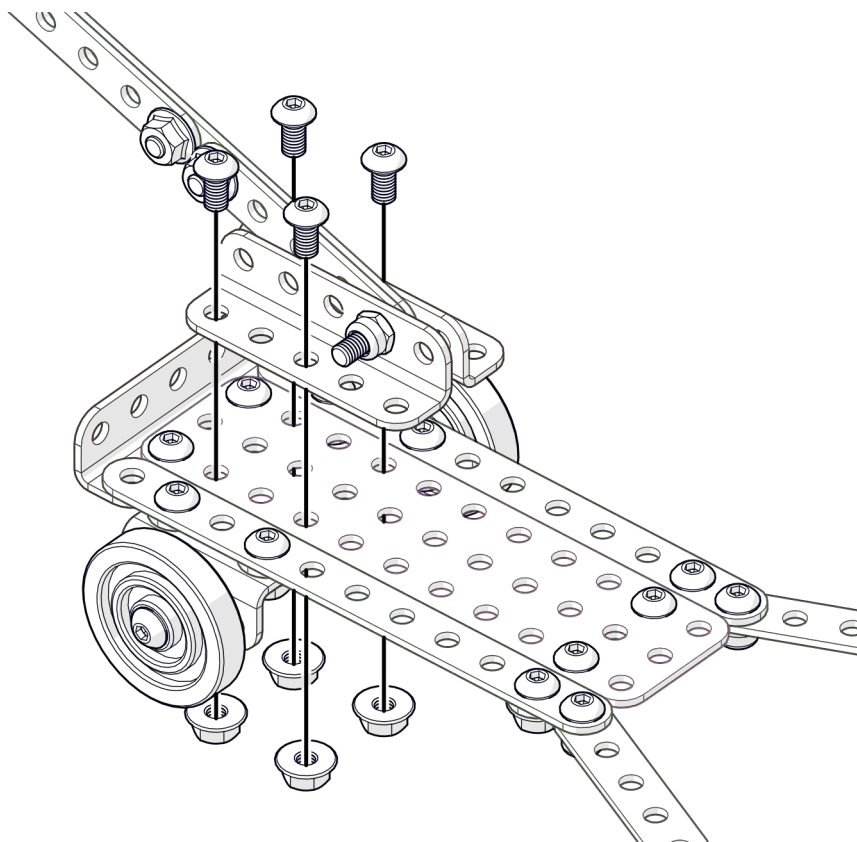

4

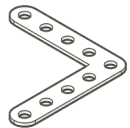

2x

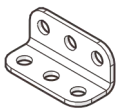

2x

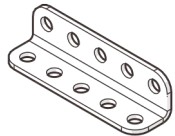

1x

M4x8



8x



8x

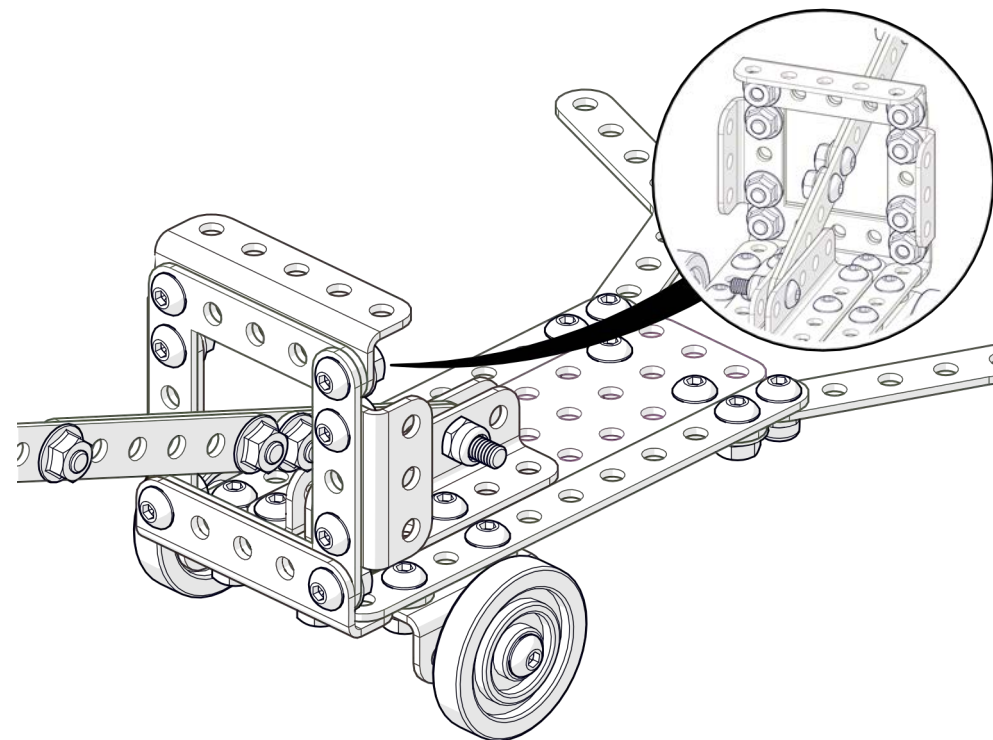
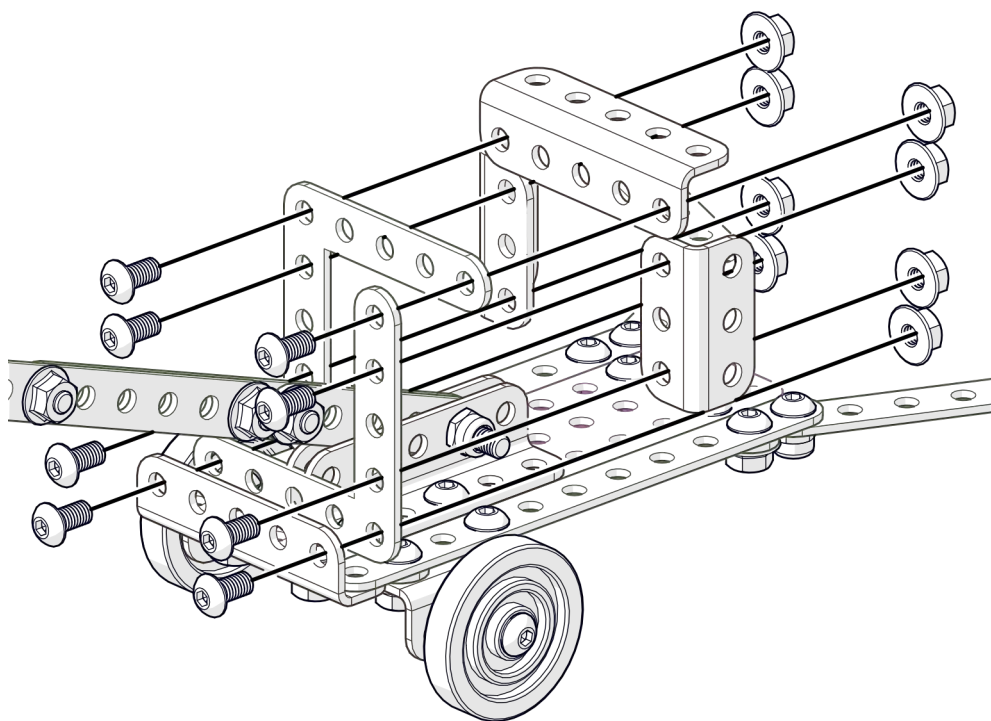

НАУЧИМ ИЗОБРЕТАТЬ
БУДУЩЕЕ

TRIK



[trikset](#)

trikset.com

support@trikset.com

