

НАУЧИМ ИЗОБРЕТАТЬ  
БУДУЩЕЕ

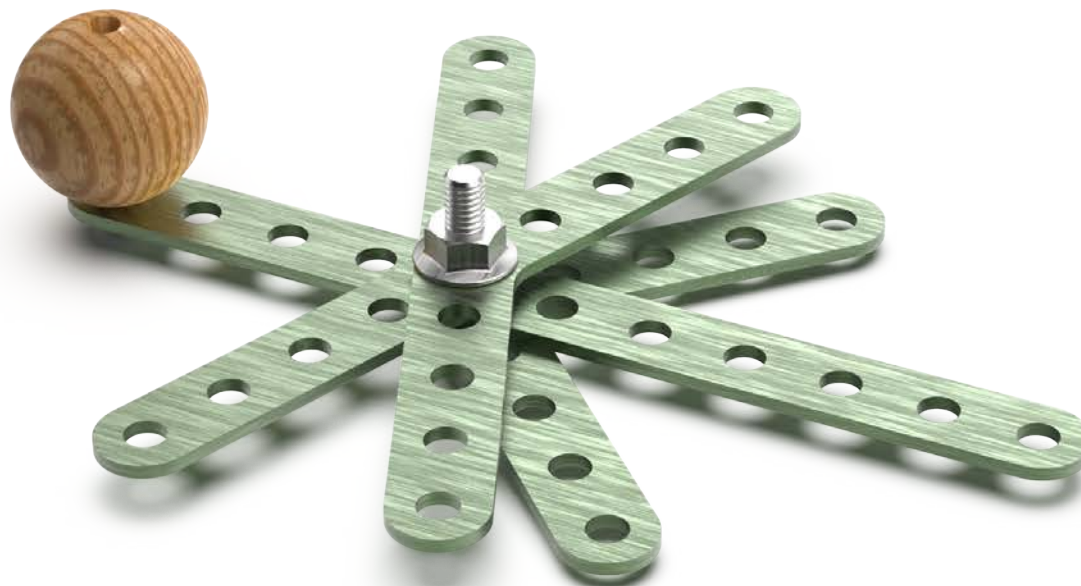



TRIK

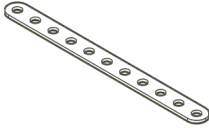
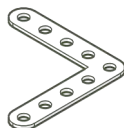
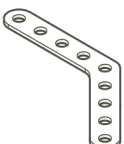

Стрекоза

Инструкция по сборке

## Перечень деталей

Название детали	Изображение	Количество (шт.)
Пластина 1x11		1
Угол плоский 90° 5x5		1
Угол плоский 135° 5x5		2
Винт М4x8	M4x8 	1
Винт М4x16	M4x16 	1
Гайка М4 фланцевая		1
Шарик деревянный 20 мм		1

1

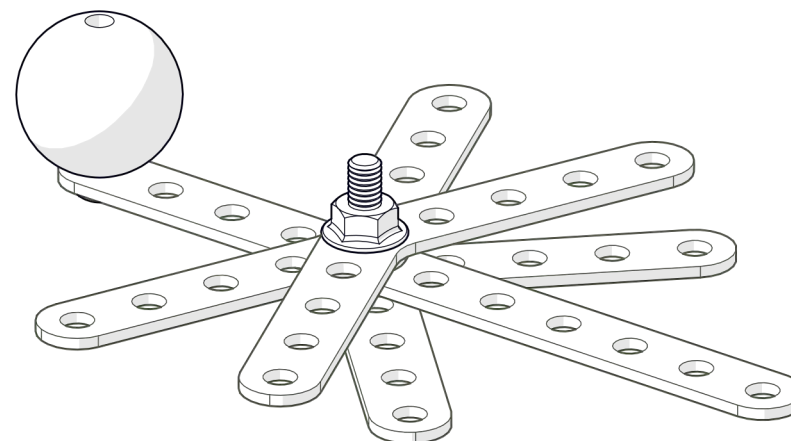
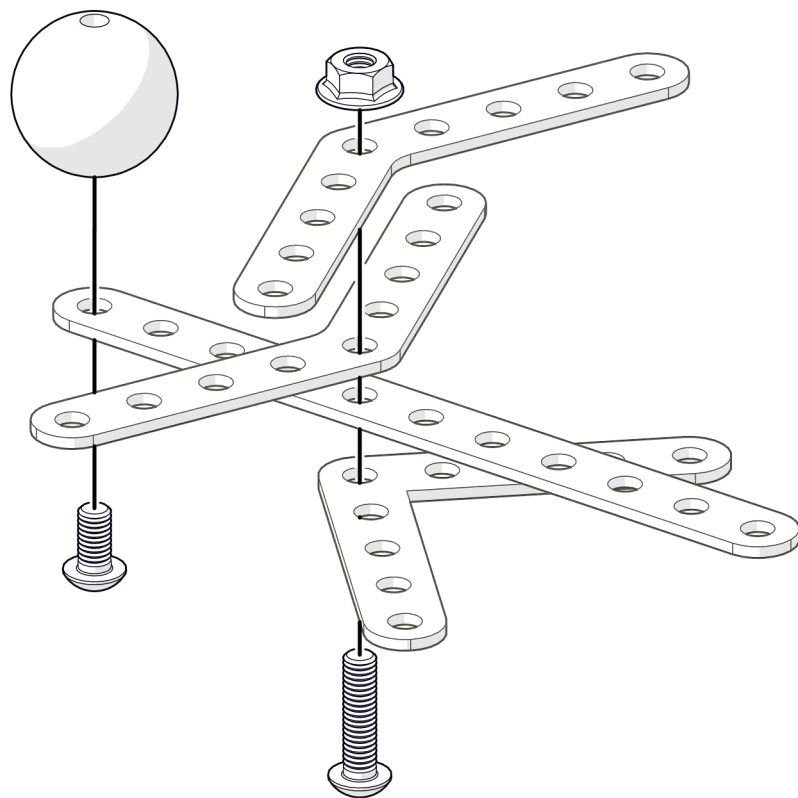
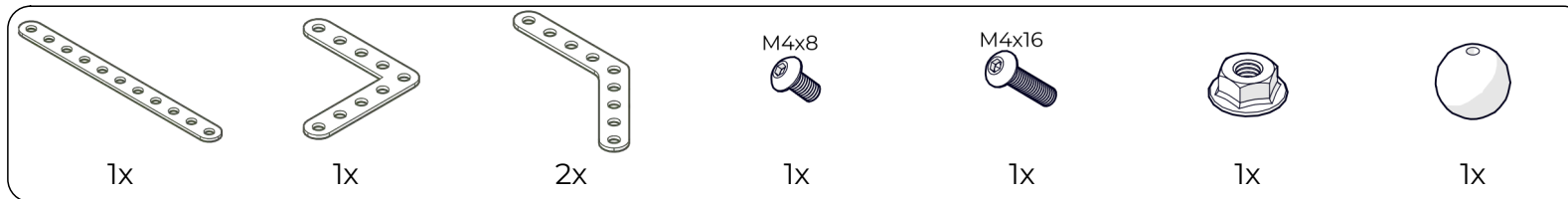

НАУЧИМ ИЗОБРЕТАТЬ  
БУДУЩЕЕ

TRIK

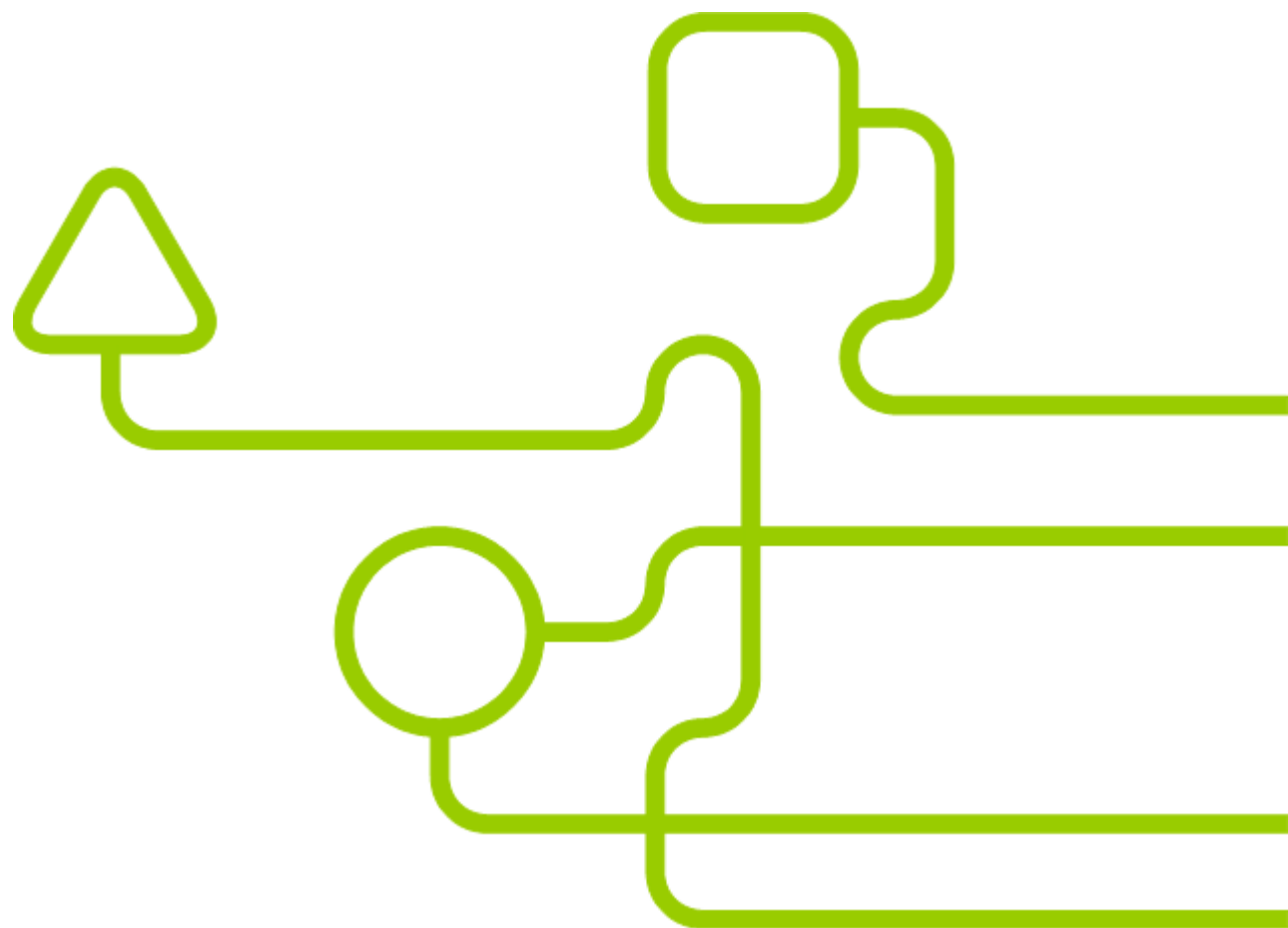

[trikset](#)

[trikset.com](#)

[support@trikset.com](mailto:support@trikset.com)

