

НАУЧИМ ИЗОБРЕТАТЬ  
БУДУЩЕЕ

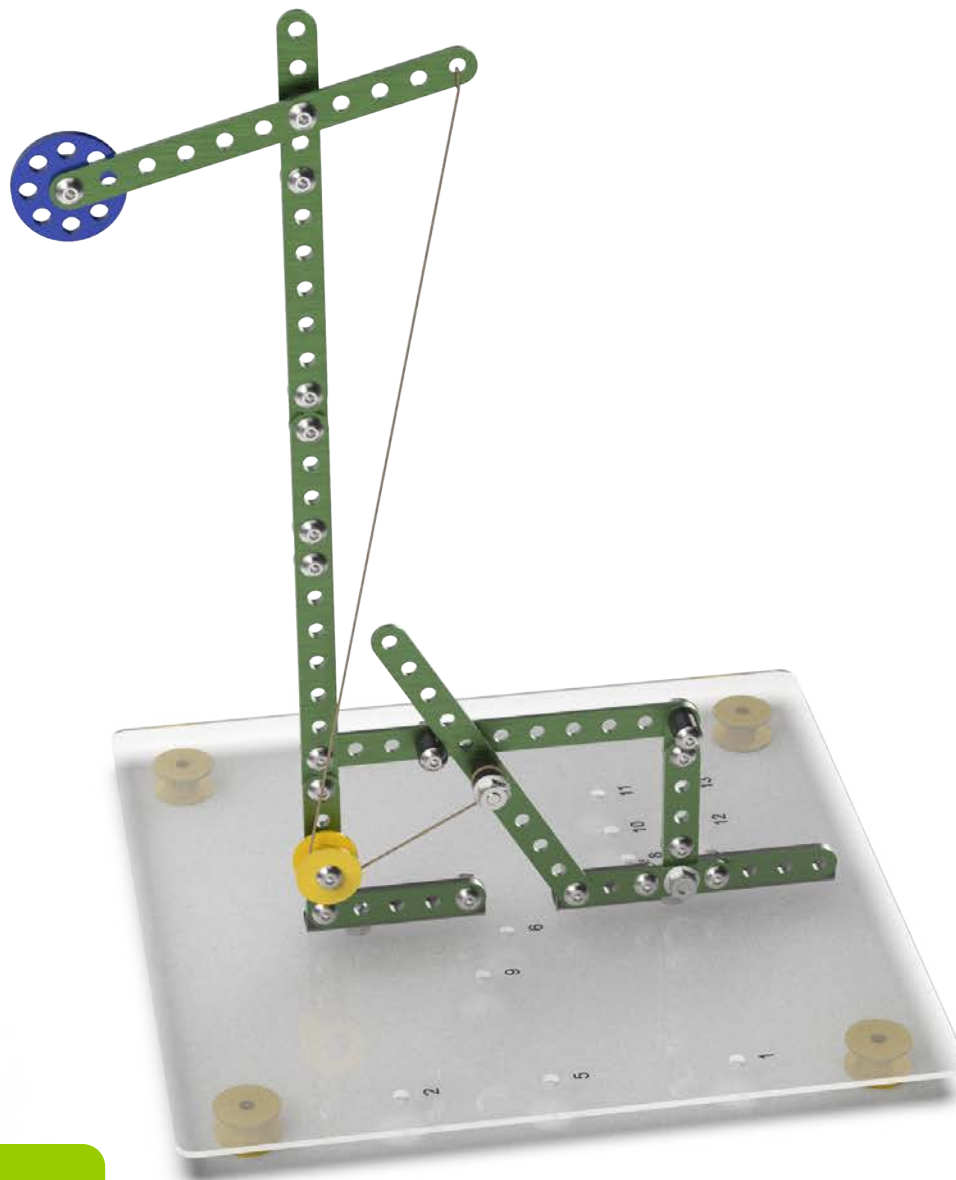









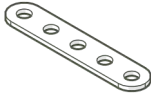

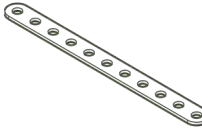

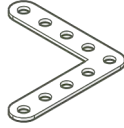
TRIK

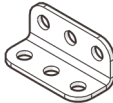

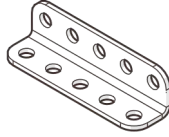
# Семафор

Инструкция по сборке

## Перечень деталей

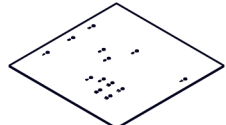
Название детали	Изображение	Количество (шт.)	Название детали	Изображение	Количество (шт.)
Пластина 1x5		2	Гайка М4 фланцевая		21
Пластина 1x11		7	Гайка М4 стопорная		3
Угол плоский 90° 5x5		2	Кольцо 3.4 мм		3
Угол (1_1)x3		1	Кольцо 5 мм		5
Угол (1_1)x5		2	Планшайба		1
Винт М4x8	 M4x8	17	Шкив		5
Винт М4x16	 M4x16	6	Катушка с нитью 3 м		1
Винт М4x25	 M4x25	1	Основание №1 210x210 мм		1

1

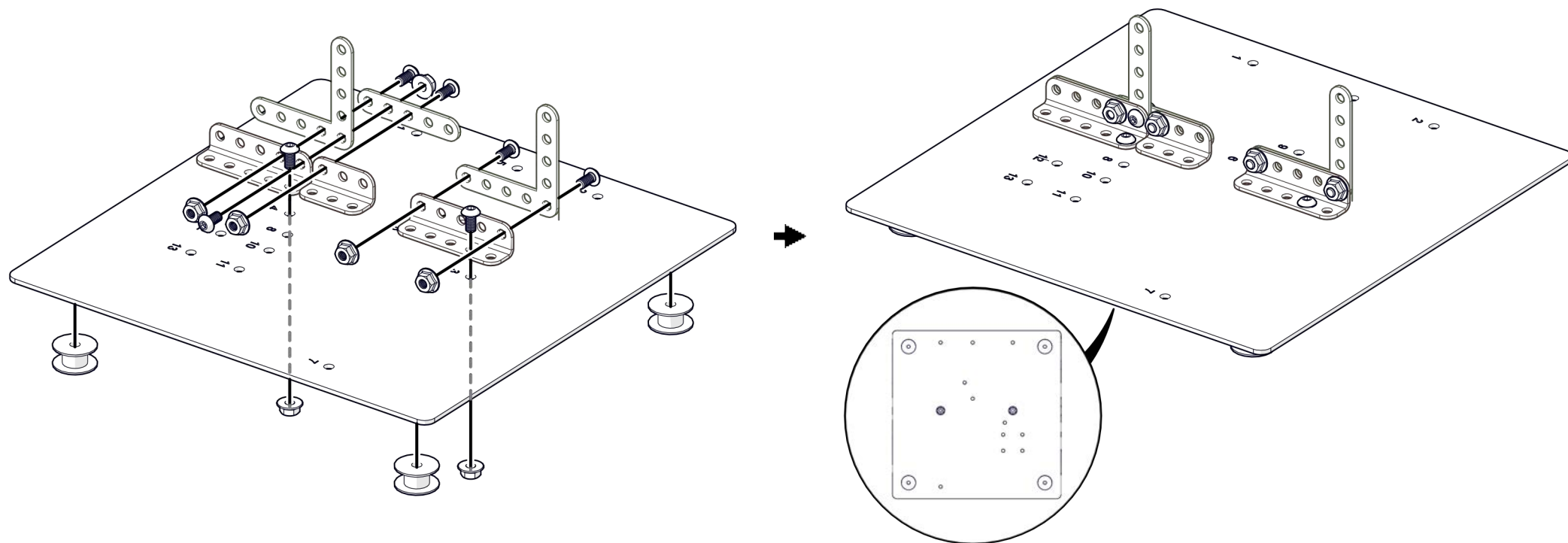
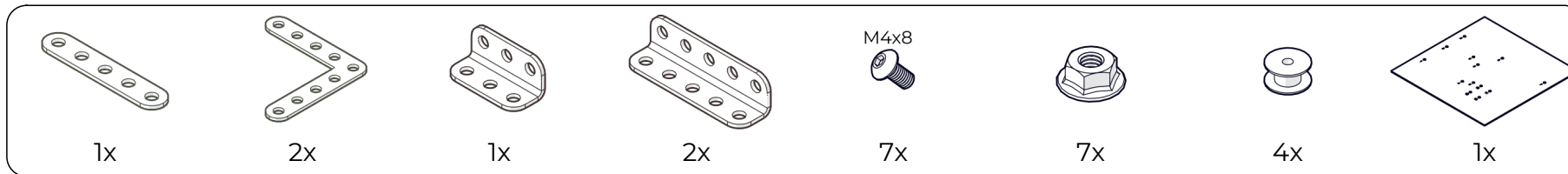

2

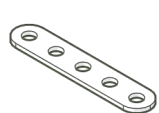

1x

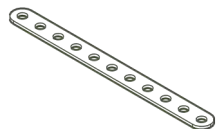

7x



10x



6x



1x



14x



3x



3x



5x



1x



1x



1x

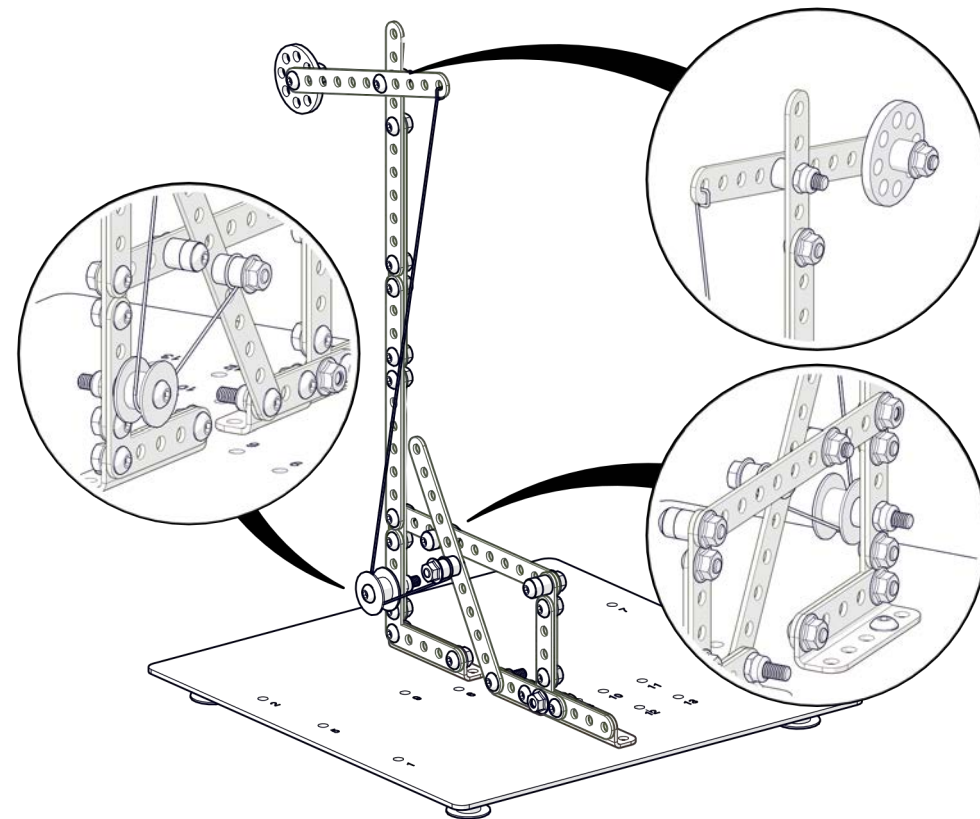
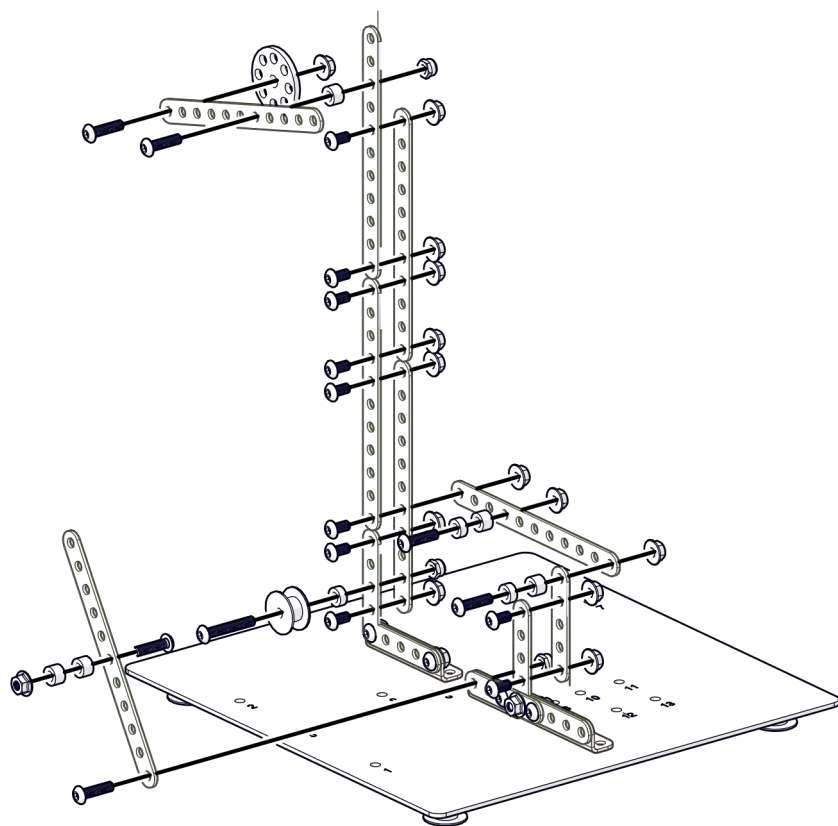

НАУЧИМ ИЗОБРЕТАТЬ  
БУДУЩЕЕ

TRIK

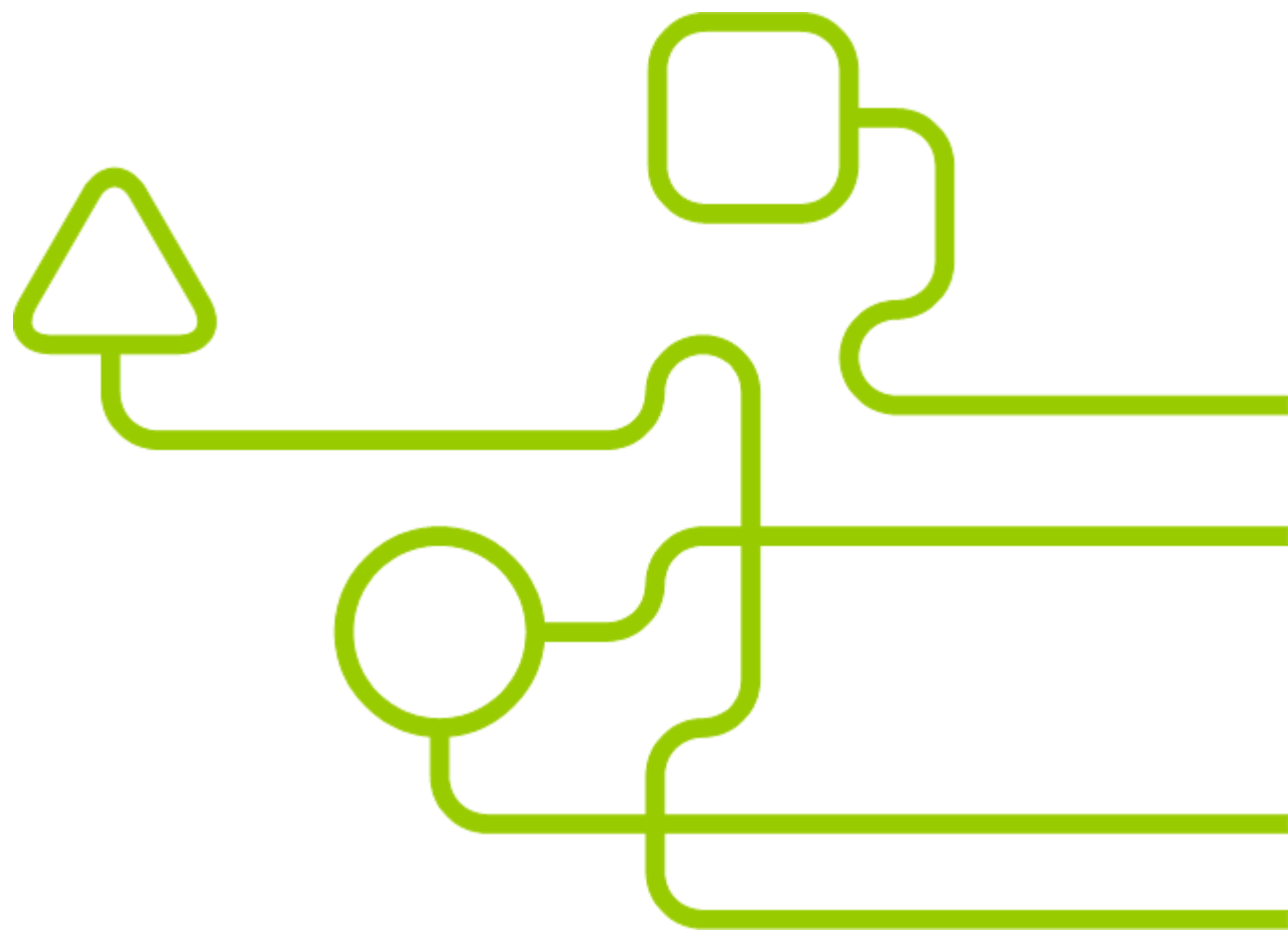

[trikset](#)

[trikset.com](http://trikset.com)

[support@trikset.com](mailto:support@trikset.com)

